

Spectralink Butterfly

User Guide

Copyright Notice

© 2013 Spectralink Corporation All rights reserved. Spectralink™, the Spectralink logo and the names and marks associated with Spectralink's products are trademarks and/or service marks of Spectralink Corporation and are common law marks in the United States and various other countries. All other trademarks are property of their respective owners. No portion hereof may be reproduced or transmitted in any form or by any means, for any purpose other than the recipient's personal use, without the express written permission of Spectralink.

All rights reserved under the International and pan-American Copyright Conventions. No part of this manual, or the software described herein, may be reproduced or transmitted in any form or by any means, or translated into another language or format, in whole or in part, without the express written permission of Spectralink Corporation.

Do not remove (or allow any third party to remove) any product identification, copyright or other notices.

Notice

Spectralink Corporation has prepared this document for use by Spectralink personnel and customers. The drawings and specifications contained herein are the property of Spectralink and shall be neither reproduced in whole or in part without the prior written approval of Spectralink, nor be implied to grant any license to make, use, or sell equipment manufactured in accordance herewith.

Spectralink reserves the right to make changes in specifications and other information contained in this document without prior notice, and the reader should in all cases consult Spectralink to determine whether any such changes have been made.

NO REPRESENTATION OR OTHER AFFIRMATION OF FACT CONTAINED IN THIS DOCUMENT INCLUDING BUT NOT LIMITED TO STATEMENTS REGARDING CAPACITY, RESPONSE-TIME PERFORMANCE, SUITABILITY FOR USE, OR PERFORMANCE OF PRODUCTS DESCRIBED HEREIN SHALL BE DEEMED TO BE A WARRANTY BY SPECTRALINK FOR ANY PURPOSE, OR GIVE RISE TO ANY LIABILITY OF SPECTRALINK WHATSOEVER.

Spectralink Corporation,
2550 55th Street,
Boulder CO 80301,
USA

Spectralink Europe ApS,
Langmarksvej 34,
8700 Horsens,
Denmark

Content

Getting Started	4
Handset Information	4
Charger Information	4
Battery Information	4
About Your Butterfly Handset	8
Handset Display	10
Navigating the Handset	13
Basic Handset Options	15
Turning Handset On/Off	15
Adjusting Speaker Volume	15
Locking/Unlocking Keypad	15
Silent mode On/Off	16
Answer Calls and End Calls	16
Incoming Call Mute	16
Speakerphone On/Off	16
Microphone Mute On/Off	16
Voice Mail	16
Making Calls	17
Off Hook Dialling (Dial Directly)	17
On Hook Dialling (Pre-Dial)	17
Dial from Phone Book	17
Dial from Call List/Call Register	18
Corporate Directory Calls (System Dependant)	19
Answering Calls	20
Auto Answer	20
Mute an Incoming Call	20
End a Call	20

Reject a Call	20
During Calls	21
Call Transfer	21
Call Hold	21
Call Waiting	22
Call Forward Unconditional	23
Turn Loudspeaker On/Off	23
Turn Microphone Mute On or Off	23
Enter Phone Book	23
Shortcuts	24
Personal Shortcuts	24
Predefined Shortcuts	24
Using The Menu	26
Description of Menus	26
List of Menu Functions	27
Phone Book	29
Using the Alphanumeric Keyboard	29
Managing Contact	29
Speed Dial	32
Call Register	33
Incoming Calls	33
Outgoing Calls	34
Missed Calls	35
Delete Call Lists	36
Messages	37
Writing, Sending and Saving Messages	37
Using Templates	38

Reading Messages 40
Replying to a Message 41
Deleting Messages 43

Status 45

Handset Options Status 45
Silent 45
Auto Answer 45
Battery 45
Ringer Tone 46
Volume 46
General Information 46

Settings 47

Ringing Volume 47
Ringing Tone 47
Alerting Volume 47
Vibrator 48
Silent Mode 48
Auto Key Lock 49
Backlight 50
Auto Answer 51
Out of Range 51
Advanced... 52

General Information 57

Troubleshooting 57
Information 57
International Regulatory and Product Information 58

Chapter 1: Getting Started

Read all information in this section before you use your handset.

Handset Information

Never use your handset:

- in the vicinity of electrical detonators
- in shielded rooms
- in areas where radio transmission is forbidden
- in aircrafts

Do not place a handset near:

- water, moisture or damp areas
- heat sources, direct sunlight or unventilated areas
- devices which generate strong magnetic fields such as electrical appliances, fluorescent lamps, computers, radios, televisions or fax machines
- areas where the handset can be covered, its ventilation impaired, liquid spilled on the unit or objects inserted into the handset through any openings.
- areas with dust, vibration, shock or temperature extremes

Check for small metal objects in the handset earpiece/mouthpiece before using the handset.

Do not store or locate flammable liquids, gases, or explosive materials in the same compartment or vicinity as the cordless handset, its parts or accessories.

Charger Information

A micro USB charger is used to charge this handset, having the following characteristics:

- Location: Worldwide
- Part Number: 84642604

Battery Information

Read the following information before you handle the batteries:

- Do not leave a battery where it could be subjected to extremely high temperatures.
- Do not charge battery when the ambient room temperature is above 40°C/104°F or below 0°C/32°F.
- Do not replace batteries in potentially explosive environments, such as rooms where flammable liquids or gases are present.
- Do not charge batteries unless you use the approved power adaptor and the proper batteries.
- Use only Ni-MH rechargeable batteries, type AAA 1.2V in the Spectralink Butterfly Handset.
- Do not disassemble, short circuit or dispose of in fire.
- Do not mix with different battery types.
- Do not let battery or power adaptor come into contact with conductive metal objects.
- Power handset off before removing the battery.

Install and Replace Batteries

- 1 To install/replace the batteries, first remove the battery cover by using the small opening on top of the handset. Use a paperclip or a wide screwdriver.



- 2 When the gap at the top opens, lift off the battery cover.
- 3 Insert/replace the batteries. Tilt the battery and position it in the battery compartment with the (+) terminal first. Press the battery into place so that the (-) terminal is also connected.

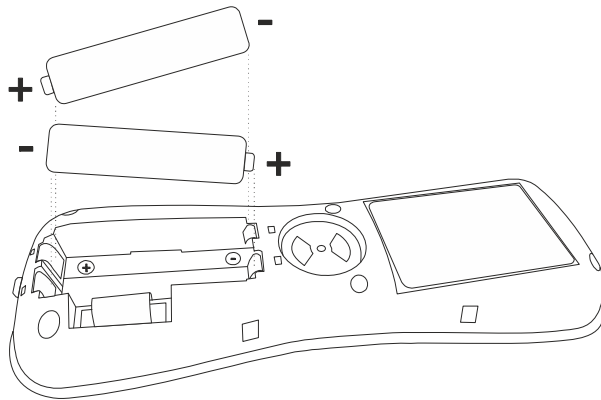

- 4 Press the back cover in locked position (when you hear a click, the back cover is in position). Use only Ni-MH rechargeable batteries.

Charging Battery



During normal operation, it takes approximately 4 hours to charge the handset from fully discharged to its full capacity.

Connect handset to micro USB charger



For correct charging, be sure the room temperature is between 0°C/32°F and 40°C/104°F. Do not place the handset in direct sunlight.

If the handset is turned off, when connected to micro USB charger the handset automatically turns on.

When charging, the display shows the blue charging icon  in the status bar. The charging icon is replaced by the green fully charged icon , when the batteries are fully charged (when handset is removed from the micro USB charger, the charging icon disappears).

It is necessary to recharge batteries when display shows the battery low icon , or if the handset cannot be turned on.

Battery Capacity

The capacity of the batteries depends on the use of backlight and talk time.

Batteries capacity in active mode:

- Up to 15 hours active talking time.
- Up to 20 hours active talking time in economy mode

Batteries capacity in standby mode:

- 150 hours when display backlight is turned off.

Battery Disposal

AAA Ni-mh batteries must be disposed of properly. Do not dispose of the batteries in office or household waste.

AAA Ni-mh batteries are recyclable. You can help preserve the environment by returning your unwanted batteries to your nearest recycling center for recycling or proper disposal.

Visit www.spectralink.com/battery-recycling for further guidance on battery recycling.

Chapter 2: About Your Butterfly Handset

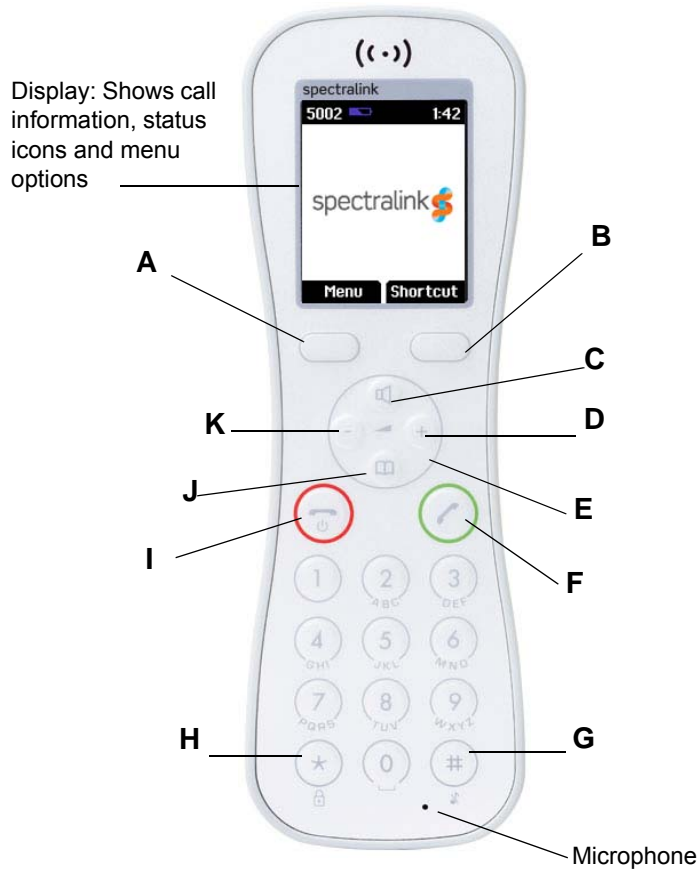

A	Left Softkey	
On hook - the handset is in standby mode.	<ul style="list-style-type: none"> Enters main menu. Confirms choices in menu. Turns handset off with a long (three second) key press. 	
Off hook - the handset is in active mode.	<ul style="list-style-type: none"> Mutes microphone 	
B	Right Softkey	
On hook (idle)	<ul style="list-style-type: none"> Returns to previous menu. 	
Off hook (active)	<ul style="list-style-type: none"> Turns loudspeaker on. Not available on 7710. 	

C	Speakerphone On/Off	
D	Missed Call List	
	On hook (idle)	<ul style="list-style-type: none"> • Navigates to Missed Call menu
	Off hook (active)	<ul style="list-style-type: none"> • Adjusts volume
E	Navigation Key	
F	Off Hook	
	Off hook (active)	<ul style="list-style-type: none"> • Activates dial tone • Swaps between two calls
G	Silent mode Key	
	On hook (idle)	<ul style="list-style-type: none"> • Sets silent mode on/off (Menu + #)
H	Key pad lock	
	On hook (idle)	<ul style="list-style-type: none"> • Sets silent mode on/off (Menu + #)
I	On Hook	
	On hook (idle)	<ul style="list-style-type: none"> • Exits menu
	Off hook (active)	<ul style="list-style-type: none"> • Ends calls
J	Phonebook	
K	Call list/volume control	
	On hook (idle)	<ul style="list-style-type: none"> • Navigates to Call list Menu
	Off hook (active)	<ul style="list-style-type: none"> • Adjusts volume

Handset Display

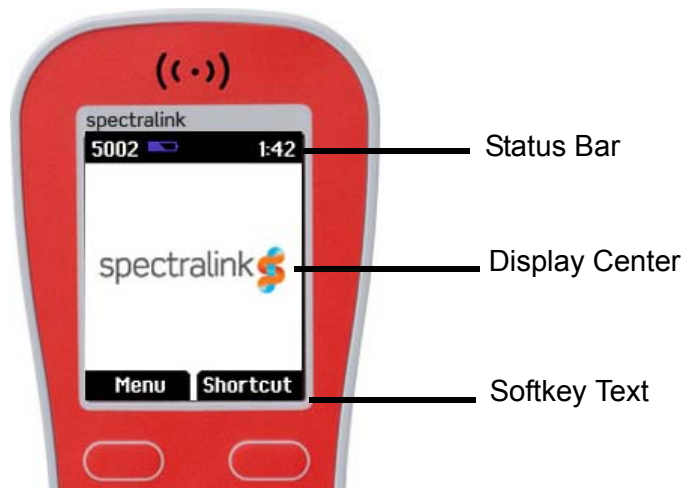

The display is divided in three parts: **Status Bar**, **Display Center** and **Softkey Text** (see figure above).

Information shown in Status Bar:

- on hook (idle): Display shows user ID, personal settings and time.
- off hook: Display shows actions (“calling”, “connected”, etc.)

Information shown in Display Center:

- on hook (idle): Display shows standby logo or call information when receiving an incoming call
- off hook: Display shows a telephone icon.

Information shown in Softkey Text:

- on hook (idle): Display shows **Menu** and **Shortcut**.
- off hook - display shows **Mic Mute** function.
- Menu: gives access to the different functions of the handset.
- Shortcut: Personal shortcuts consist of functions you have chosen to add to a list of shortcuts.

Status Icons

The following icons may appear in Status Bar or Display Center:



The no signal icon indicates that handset is out of coverage.



The low battery icon indicates that battery capacity is low.



The telephone icon appears when you miss a call.



The telephone icon appears when an external incoming call arrives.



The telephone icon appears when an internal incoming call arrives



The telephone icon appears when you make a call.



The telephone icon appears when the handset is off hook or a call is connected.



The envelope icon appears when you receive a message



The charging icon appears when the handset is placed in charger.



The fully charged icon appears when the battery is fully charged.



The key lock icon indicates that the entire keypad is locked.



The silent icon appears when all sounds are disabled.



The loudspeaker icon appears when loudspeaker is turned on.



The mute icon appears when mic mute is turned on. Mic mute is an abbreviation of microphone mute.



Appears when auto answer is turned on.



Appears when a voice mail message arrives.



Appears when there is an unread message in the inbox.



Appears when you can call back to the person who has sent you a message.

Display Backlight

The display backlight automatically turns on when an incoming call or message arrives, or if a key is pressed.

The backlight turns off when the handset is idle after a preset period of time delay.

You can set the standby mode backlight to Dimmed or Off, and you can disable the backlight to save power. For more information, see [“Backlight”](#).

Navigating the Handset

The main part of the functions of the handset are grouped into different menus. You navigate the handset using two softkeys and a four-way navigation key. The following figure illustrates the connection between these keys and the text shown in display.

The following picture shows the handset when it is on hook (idle).

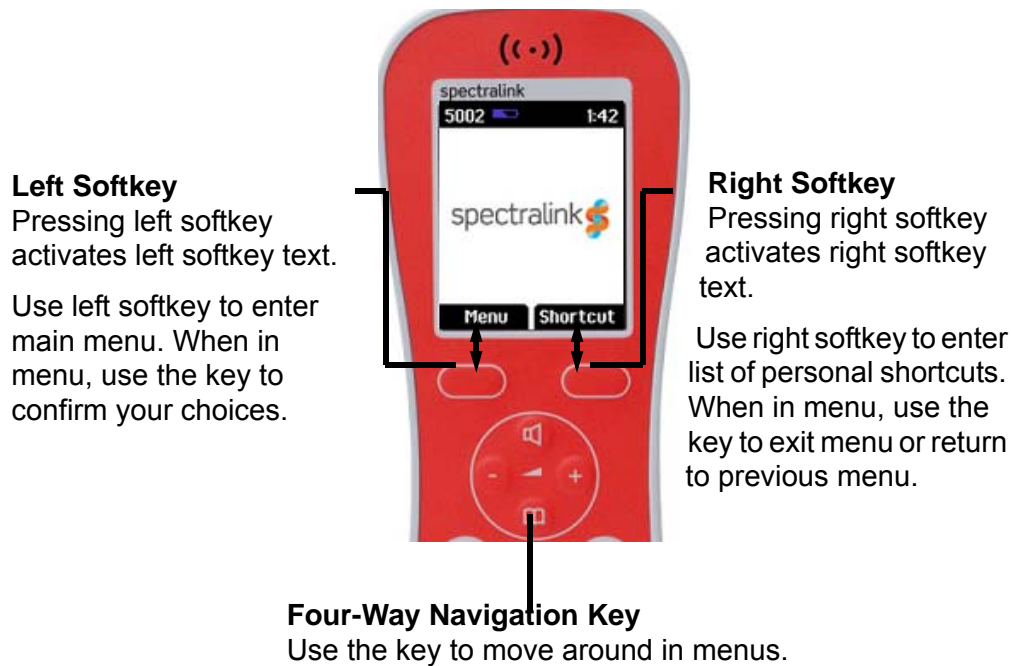

The handset also offers both personal and predefined shortcuts to selected functions in the menu. Use the key to move around in menus.

Entering Main Menu

- To enter main menu press left softkey to activate Menu.

Scrolling in Menus

- When in menu, press top or bottom of navigation key to scroll up and down in menu.

Confirming Choices

- When in the relevant menu, press **Select** to confirm your choices. Various terms are being used in the softkey text according to the context of the specific function.

Navigating Cursor

- When in the relevant menu, press left or right side of navigation key to move cursor from side to side. This is especially relevant when you are writing/editing words or entering/editing numbers and want to delete a letter or digit.
- To delete, simply place cursor behind the letter or digit and press right softkey to activate **Delete**.

Returning to Previous Menu

- When in menu, press right softkey to activate **Back** or **Exit**. You return to the previous menu.

Leaving Menus

- To leave menu, press  .

Chapter 3: Basic Handset Options

Turning Handset On/Off

To turn handset on:

- Press  to turn handset on.

To turn handset off:

- 1 Press  until the question **Turn off?** appears in display.
- 2 Press **Yes** to confirm.



Note

When you turn handset off, all content of call register and settings of time and date are deleted. The subscribed system may resend time and date settings.

Adjusting Speaker Volume

You can only adjust the speaker volume when handset is off hook. The handset remembers the speaker volume until you make a new adjustment.

During a telephone conversation you can adjust the speaker volume at any time.

To turn speaking volume up:

- While off hook, press (+) on the navigation key to turn volume up.

To turn speaker volume down:

- While off hook, press (-) on the navigation key to turn volume down.

Locking/Unlocking Keypad

Lock keypad to prevent keys from being accidentally pressed.

Lock or Unlock Keypad:



- Press **Menu** followed by ***** to lock keypad.
- Press **Unlock** followed by ***** to unlock keypad.

To answer a call when the keypad is locked, press . When you end the call, the keypad automatically locks.

Silent mode On/Off

- Press the **Menu** button, followed by the # button to turn the handset silent mode on/off. In silent mode the ringer will be muted and the vibrator activated.

Answer Calls and End Calls



- To answer a call, press .
- To end a call, press .

Incoming Call Mute

Press **Silence** to mute the incoming ringer signal.

Speakerphone On/Off

Enable or Disable the Speakerphone

- While on a call, press  on the navigation key to enable speakerphone.
- To disable speakerphone, press .
- While idle, press  to hook off and to enable speakerphone.

Microphone Mute On/Off

- While on a call, press Mic mute to turn microphone mute on.
- Press Mic on to turn microphone mute off.

Voice Mail

- If you have a new voice mail message waiting, a blue envelope icon appears in the display. The procedure for retrieving voice mail is system dependant. Contact your system administrator for more information.



Chapter 4: Making Calls

The handset must be subscribed and registered to make a call.



For internal calls, dial extension number. Contact your system administrator for a list of these extension numbers.

For external calls, dial external code (or line pool code) to access an external line, then dial external number. Contact your system administrator to confirm what external code or line pool code to use.

Off Hook Dialling (Dial Directly)





- 1 Press  to get dial tone.
- 2 Dial number.
- 3 Press  to end the call.

On Hook Dialling (Pre-Dial)

- 4 Dial number.
- 5 Press  to make a call.
- 6 Press  to end the call.

Dial from Phone Book

The find name function makes it easy to find a contact.

- 1 Press **Menu** to enter main menu.
- 2 Scroll to **Phone Book** and press **Select**.
- 3 Scroll to **Find name** and press **Select**.
- 4 To find a name you can:
 - Scroll until you reach the desired name. To scroll through the names quickly press the navigation key continuously.
 - Use quick search by pressing the first letter(s) (max. 5 letters) of the desired name.
- 5 Press  to make a call.
- 6 If more than one number: scroll to the desired number and press .
- 7 The display icon  appears until call is connected.
- 8 Press  to end the call.

Dial from Call List/Call Register

Call list/Call register shows up to 40 of your latest incoming, outgoing and missed calls. When call list/call register memory is full, the handset automatically erases the oldest call when a new call is received in call list/call register.

- Incoming calls are illustrated with green arrows
- Outgoing calls are illustrated with blue arrows
- Missed calls are illustrated with red arrows

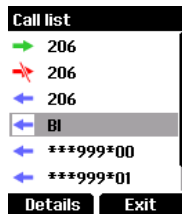

Note

When the handset is turned off, all content in the call lists and call register is deleted.

Dial from call list:

- 1 While on hook, press left side of navigation key to enter call list.
- 2 Scroll to the desired name or number and press .

Dial from missed call list:

- 1 While on hook, press right side of navigation key to enter missed call list.
- 2 Scroll to the desired name or number and press .

Dial from Call Register List:

- 1 Press **Menu** to enter main menu.
- 2 Scroll to **Call register** and press **Select**.
- 3 Scroll to the desired list and press **Select**.
- 4 Scroll to the desired name or number and press .

Redial

- 1 Press **Menu** to enter main menu.
- 2 Scroll to **Call register** and press **Select**.
- 3 Scroll to **Outgoing calls** and press **Select**.
- 4 Scroll to the desired name or number and press .

Speed Dial Calls

If you have assigned a number to one of the speed-dialing keys 0-9, do the following:

- While on hook, press digit equivalent to number of the contact in the speed dial list continuously until call is initiated.

Corporate Directory Calls (System Dependant)

- 1 Press **Menu** to enter the main menu.
- 2 Scroll to **External Services** and then press **Select**.
- 3 Press the left (-) or right (+) side of the navigation key to scroll to find the name or spell the name out using the keys (2-9).
- 4 When the desired name is displayed, press  to dial the number.

Chapter 5: Answering Calls

The handset must be subscribed and registered to answer a call.

When handset rings, display shows the icon for incoming calls  and the caller information appears below if supported by the subscribed system.

- Press  to answer a call when your handset rings.



Note

You can distinguish between an internal and external call by the ring tone. This is a system dependant feature.

Auto Answer

When auto answer is turned on, the handset automatically goes off hook when an incoming call arrives.

If subscribed to a wireless solution, the handset automatically goes on hook when calls are ended.

- 1 Press **Menu** to enter main menu.
- 2 Scroll to **Settings** and press **Select**.
- 3 Scroll to **Auto answer** and press **Select**.
- 4 Scroll to **On** or **Off** and press **Change**.
- 5 Scroll to **Settings**, press **Change** and press **Select** to activate/deactivate loudspeaker.

When charging, auto answer is inactive.

Mute an Incoming Call

- Press **Silence** to mute the incoming ringer signal.

End a Call

- Press  to end a call.

Reject a Call

Rejecting a call is system dependent. If supported by the subscribed system, do the following:

- When the handset rings, press **Reject** to refuse the call. The rejected call is registered as a missed call.

Chapter 6: During Calls

Call Transfer



Call transfer is a system dependant feature. How you use the feature depends on whether your system is subscribed to a SIP enabled Spectralink DECT or IP DECT server or a Spectralink DECT or IP DECT Server.

Call Transfer: SIP Enabled Spectralink DECT Server or IP DECT Server

Call Transfer (Blind)



- 1 While on a call, press , and then dial the extension or external number.
- 2 Press **Transfer** to send the call through and to hang up.

Call Transfer (Attended)



- 1 While on a call, press , and then dial the extension or external number.
- 2 Press .
- 3 When the other caller answers, press **Transfer** to send the call through and to hang up.

Call Transfer: Legacy Spectralink DECT or IP DECT Server

Call Transfer (Blind)

- 1 While on a call, press .
- 2 Dial the extension or external number.
- 3 Press  to send the call through and to hang up.

Call Transfer (Attended)

- 1 While on a call, press .
- 2 Dial the extension or external number.
- 3 When the other caller answers, press  to send the call through and to hang up.



Call Hold

Call Hold is a system dependant feature. How you use the feature depends on whether your system is subscribed to a SIP enabled Spectralink DECT or IP DECT server or a Spectralink DECT or IP DECT Server.

Call Hold: SIP Enabled Spectralink DECT or IP DECT Server

- To place an active call on hold, press **Hold**.
- To retrieve the call, press **Resume**.



Call Hold: Legacy Spectralink DECT or IP DECT Server

- To place an active call on hold, press .
- To retrieve the call, press .





Call Waiting

Call waiting is a system dependant feature. How you use the feature depends on whether your system is subscribed to a SIP enabled Spectralink DECT or IP DECT server or a Spectralink DECT or IP DECT Server.

Call Waiting: SIP Enabled Spectralink DECT or IP DECT Server





- While on a call, press **Accept** to answer a second incoming call. The first call will automatically be put on hold.
- To reject a second incoming call, press **Reject**.
- To disconnect the active call and return to the waiting call, press .
- To end both calls, press  twice.
- To swap between two calls, press .

Call Waiting: Legacy Spectralink DECT or IP DECT Server

- While on a call, press  to answer a second incoming call. The first call will automatically be put on hold.
- To reject a second incoming call, press the left side of the navigation key (-) for three seconds.
- To disconnect the active call, press , and to return to the waiting call, press .
- To end both calls, press .
- To swap between two calls, press .

Call Forward Unconditional



Call Forward Unconditional is a system dependent feature.

- To enable CFU press *21* followed by a number, then press #.
- Press  to enable CFU. Confirmation in display and a tone indicates that the feature has been activated.
- Press  to hang up.
- To disable CFU, press #21#, then press .
- Press  to hang up.

21 code can be changed in the Spectralink DECT Server to fit your standard.

Turn Loudspeaker On/Off

Turning loudspeaker on allows other people in the room to listen to and participate in the conversation. You may set the handset on a desk or table and leave your hands free.

- 1 While on a call, press  on the navigation key to enable speakerphone.
- 2 To disable speakerphone, press .
- 3 While idle, press  to hook off and to enable speakerphone.

Turn Microphone Mute On or Off

Turning microphone mute on will mute your voice. That is you can hear the other party but they cannot hear you.

- 1 While on a call, press **Mic Mute** to turn microphone mute on.
- 2 To turn microphone mute off, press **Mic on**.

Enter Phone Book

While on a call, you can access the find name function to scroll through names and numbers using the up/down navigation key.

Chapter 7: Shortcuts

While on a call, you can access the find name function to scroll through names and numbers using predefined shortcuts (up/down navigation keys).

The handset contains two types of shortcuts:

- Personal shortcuts
- Predefined shortcuts

Personal Shortcuts

Personal shortcuts consist of functions you have chosen to add to a list of shortcuts. The list is assigned to the right softkey. Personal shortcuts give you easy access to the functions you use most often. You can only use personal shortcuts when the handset is in standby mode (on hook).

Add a shortcut:

- 1 While on hook, press **Shortcut** to enter the shortcut function.
- 2 Scroll to **Edit shortcuts** and press **Select**.
- 3 Scroll to the function, you want to make a shortcut to.
- 4 Press **Select** to add the function to the list of personal shortcuts.

Use a shortcut:

- 1 While on hook, press **Shortcut** to enter the shortcut function.
- 2 Scroll to the desired shortcut and press **Select**.



Remove a shortcut:

- 1 While on hook, press **Shortcut** to enter the shortcut function.
- 2 Scroll to **Edit shortcuts** and press **Select**.
- 3 Scroll to the desired shortcut and press **Select** to remove the function from the list of shortcuts.

Predefined Shortcuts

Predefined shortcuts are unchangeable and assigned to different keys.

In the following you find a list of predefined shortcuts and a description of how to access and use them.

- **Call List:** While on hook, press (-) on the left side of the navigation key to enter call list.
 - Incoming calls are illustrated with green arrows
 - Outgoing calls are illustrated with blue arrows
 - Missed calls are illustrated with red arrows
- **Exit Menu:** When in menu, press **Exit**.
- **Phone Book Search:** While on or off hook, press  on the bottom of the navigation key.
- **Keypad Locked/Unlocked:** While on hook, press **Menu** followed by ***** (Display shows the key lock icon ) to lock/unlock keypad.
- **Missed Calls:** While on hook, press (+) on the right side of the navigation key to enter a list of missed calls.
- **Save Contact:** While on hook, enter number and press **Save**.
- **Silent On/Off:** Press **Menu** followed by **#** to turn the handset silent mode on/off. In silent mode the ringer will be muted and the vibrator activated (Display shows the silent icon  followed by the text **Silent mode on/off**, and a small icon is placed in status line).
- **Speed Dial:** While on hook, press digit equivalent to number of the contact in the speed dial list continuously until call is started.

Chapter 8: Using The Menu

The handset offers a range of functions that are grouped into menus. The main menu consists of seven menus: Phone Book, Call register, Messages, MSF Function, External services, Status and Settings.

If handset is in menu mode, and an incoming call arrives, then menu will be dropped and the call handled as usual. When call is ended, the handset returns to menu mode.

Description of Menus

In the following, you will find a short description of the seven menus.

Phone Book

You can store numbers and names in your phone book.

The phone book can store up to 50 names with up to four numbers each. A maximum of 24 digits, including spaces, is allowed for each number. Names are sorted alphabetically starting with their first character.

Call Register

The call register keeps track of all your recent calls as it stores up to 40 of your incoming, outgoing and missed calls.

Messages

If supported by the subscribed system, you can send and receive messages from the messages menu.

All messages are automatically stored in the inbox or outbox. Messages can store up to 8 messages. A maximum of 72 letters, including spaces, is allowed for each message.

MSF Function

MSF Function is a special function based on MSF (Message Service Function). The function requires special software in the main system.

External Services

To dial from the corporate directory list, the External Services in the handset menu must be selected.

External Services are features placed in the main system, and only available if the handset is subscribed to a Spectralink solution.

The corporate directory is a common phone book for all handsets subscribed to the actual system, and all handsets subscribed to the system are listed in this corporate directory. Additional numbers can be added to the phone book by the system administrator.

Status

Status provides a quick overview of some of the handset settings and works as a shortcut, which makes it easy to change the basic settings according to your needs.

Settings

Settings offer you the opportunity to customize the handset according to your needs. The settings can be changed at any time.

List of Menu Functions

In the following you will find a list of the different menu functions. The list gives a quick overview where to find the desired function of the handset.

Phone Book

- 1 Find name
- 2 Add name/number
- 3 Speed dial
- 4 Delete

Call Register

- 1 Incoming calls
- 2 Outgoing calls
- 3 Missed calls
- 4 Delete

Messages

- 1 New message
- 2 Inbox
- 3 Outbox
- 4 Erase messages
- 5 Templates

MSF Function

- 1 Number: system dependant

External services (system dependant)

Status

- 1 Silent
- 2 Auto answer
- 3 Economy mode
- 4 Battery
- 5 Ringer Tone
- 6 Volume
- 7 General information

Settings

- 1 Ringing volume
- 2 Ringing tone
- 3 Alerting volume
- 4 Vibrator
- 5 Silent mode
- 6 Auto key lock
- 7 Backlight
- 8 Auto answer
- 9 Out of range
- 10 Advanced...
 - Language
 - Long key
 - Economy mode
 - Login
 - Time & date

Chapter 9: Phone Book

You can store numbers and names in your phone book.

The phone book can store up to 50 names with four numbers each. A maximum of 24 digits, including spaces, is allowed for each number. Names are sorted alphabetically starting with their first character.

If the display shows **Memory full**, it is necessary to delete one or more names from the phone book.

Using the Alphanumeric Keyboard

The normal dialling keys (0-9) are used for writing the name to be placed in the phone book. By pressing the keys a certain number of times the related letters will appear in the display.

- Spaces are made by using the 0 -key.
- Key **★** changes between uppercase and lowercase letters, which is indicated on the top left-hand corner of the display.
- Pressing left (-) or right (+) side of navigation key will move the cursor.
- To delete letters, place cursor behind letter and press **Delete**.

Managing Contact

The phone book menu offers a range of possibilities to manage existing contacts and makes it easy to add, edit or delete name and number.

It is possible to add up to four numbers to a contact.

Find a Contact in Phone Book

- 1 Press **Menu** to enter main menu.
- 2 Scroll to **Phone Book** and press **Select**.
- 3 Scroll to **Find name** and press **Select**.
- 4 To find a name you can:
 - Scroll until you reach the desired name. To scroll through the names quickly press the navigation key continuously.
 - Use quick search by pressing the first letter(s) (max. 5 letters) of the desired name.
- 5 It is also possible to reach **Find name** option by pressing  on the bottom of the navigation key.

Add a New Contact (max 50)

Use the Add name/number function when you want to add a new contact to phone book.

It is possible to add up to four numbers to a contact.

- 1 Press **Menu** to enter main menu.
- 2 Scroll to **Phone Book** and press **Select**.
- 3 Scroll to **Add name/number** and press **Select**.
- 4 Type the name of the contact using the digits 2-9.
- 5 Scroll to number and enter the number to be stored (max. 24 digits).
- 6 Press **Save** to store name and number.

If display shows **Memory full**, it is necessary to delete one or more contacts from phone book.

Edit a Name or Number

You can edit name and number of a contact in phone book at any time.

- 1 Press **Menu** to enter main menu.
- 2 Scroll to **Phone Book** and press **Select**.
- 3 Scroll to **Find name** and press **Select**.
- 4 To find a name you can:
 - Scroll until you reach the desired name. To scroll through the names quickly press the navigation key continuously.
 - Use quick search by pressing the first letter(s) (max. 5 letters) of the desired name.
- 5 Press **Details**.
- 6 If more than one number: scroll to the desired number and press **Select**.
- 7 Scroll to **Edit name/number** and press **Select**.
- 8 Edit **Name** using the digits 0-9.
- 9 Scroll to **Number** and edit number using the digits 0-9.
- 10 Press **Save** to store your changes.

Add a New Number to a Contact

You can add a new number to a contact in phone book at any time. It is possible to add up to four numbers to each contact.

- 1 Press **Menu** to enter main menu.
- 2 Scroll to **Phone Book** and press **Select**.
- 3 Scroll to **Find name** and press **Select**.
- 4 To find a name you can:

- Scroll until you reach the desired name. To scroll through the names quickly press the navigation key continuously.
 - Use quick search by pressing the first letter(s) (max. 5 letters) of the desired name.
- 5** Press **Details**.
 - 6** If more than one number, press **Select**.
 - 7** Scroll to **Add new number** and press **Select**.
 - 8** Enter the new number using the digits 0-9 and press **Save**.
 - 9** Repeat step 7-8 to add another number to the contact.

Delete a Number

You can delete a single number at any time and still keep the rest of the belonging numbers of a contact.

- 1** Press **Menu** to enter main menu.
- 2** Scroll to **Phone Book** and press **Select**.
- 3** Scroll to **Find name** and press **Select**.
- 4** To find a name you can:
 - Scroll until you reach the desired name. To scroll through the names quickly press the navigation key continuously.
 - Use quick search by pressing the first letter(s) (max. 5 letters) of the desired name.
- 5** Press **Details**.
- 6** If more than one number: scroll to the desired number and press **Select**.
- 7** Scroll to **Delete number** and press **Select**.
- 8** Press **OK** to confirm.

Delete a Contact

Use the delete name and number function if you want to delete a contact and all the belonging numbers.

- 1** Press **Menu** to enter main menu.
- 2** Scroll to **Phone Book** and press **Select**.
- 3** Scroll to **Find name** and press **Select**.
- 4** To find a name you can:
 - Scroll until you reach the desired name. To scroll through the names quickly press the navigation key continuously.
 - Use quick search by pressing the first letter(s) (max. 5 letters) of the desired name.
- 5** Press **Details**.

- 6 If more than one number, press **Select**.
- 7 Scroll to **Delete name/number** and press **Select**.
- 8 Press **OK** to confirm.

Speed Dial

Speed Dial Calls

- Press and hold a key (0-9) for three seconds, until the call is initiated. You can set the keys 0 to 9 long press **Speed dial** or **Send MSF**. For more information, see [“Advanced...”](#).

Add to Speed Dial

You can assign a number to one of the speed-dialing keys 0-9. This way you only need to press a single digit to find name and number of the contact, you want to call.

You can assign up to 10 speed dial numbers.

- 1 Press **Menu** to enter main menu.
- 2 Scroll to **Phone Book** and press **Select**.
- 3 Scroll to **Find name** and press **Select**.
- 4 To find a name you can:
 - Scroll until you reach the desired name. To scroll through the names quickly press the navigation key continuously.
 - Use quick search by pressing the first letter(s) (max. 5 letters) of the desired name.
- 5 Press **Details**.
- 6 If more than one number: scroll to the desired number and press **Select**.
- 7 Scroll to **Add to speed dial** and press **Select**.
- 8 Scroll to the desired position and press **Add name**.
- 9 If position is occupied, press **Yes** to replace existing speed dial.

Delete Speed Dial

Use this function to delete a speed dial number.

- 1 Press **Menu** to enter main menu.
- 2 Scroll to **Phone Book** and press **Select**.
- 3 Scroll to **Delete** and press **Select**.
- 4 Scroll to **Speed dial number** and press **Select**.
- 5 Scroll to the desired speed dial number and press **Delete**.

Chapter 10: Call Register

The call register menu can store up to 40 of your incoming, outgoing and missed calls. Call register is divided into lists of: incoming calls, outgoing calls and missed calls.

If memory of call register is full, the handset will automatically erase the oldest call when a new call is received in call register.

When you turn off the handset, all content of call register is deleted.

Incoming Calls

Incoming call is a list of all your incoming calls sorted by date and time of the call, starting with the latest call.

If name and number of incoming call already exists in your phone book, the incoming call will be represented with the name of the contact. If name and number do not exist in your phone book, the handset cannot recognize the number and the incoming call will only be represented by the number.

In both cases, incoming call register provides details about incoming calls, such as time, date and length of conversation.

It is possible to add name and number of an incoming call to phone book or to delete an incoming call from the list.

View List of Incoming Calls

- 1 Press **Menu** to enter main menu.
- 2 Scroll to **Call register** and press **Select**.
- 3 Scroll to **Incoming calls** and press **Select**.
- 4 Press  to call.

Add an Incoming Call to Phone Book

If you have an incoming call and the number is not in phone book it is possible to add it to phone book from the incoming call list.

- 1 Press **Menu** to enter main menu.
- 2 Scroll to **Call register** and press **Select**.
- 3 Scroll to **Incoming calls** and press **Select**.
- 4 Scroll to the desired call and press **Details**.
- 5 Press **Options**.
- 6 Scroll to **Add to phone book** and press **Select**
- 7 Write the name of the contact using the digits 0-9 and press **Save**.

Delete an Incoming Call from List

- 1 Press **Menu** to enter main menu.
- 2 Scroll to **Call register** and press **Select**.
- 3 Scroll to **Incoming calls** and press **Select**.
- 4 Scroll to the desired call and press **Details**.
- 5 Press **Options** and scroll to **Delete from list**.
- 6 Press **Select** to confirm.

Outgoing Calls

Outgoing calls is a list of all your outgoing calls sorted by date and time of the call, starting with the latest call.

If name and number of the outgoing call already exist in your phone book, the outgoing call is represented with the name of the contact. If name and number do not exist in your phone book, the outgoing call is only represented by the number.

In both cases, outgoing call register provides details about outgoing calls, such as time, date and length of conversation.

It is possible to add name and number of an outgoing call to your phone book, or to delete an outgoing call from the list.

View List of Outgoing Calls

- 1 Press **Menu** to enter main menu.
- 2 Scroll to **Call register** and press **Select**.
- 3 Scroll to **Outgoing calls** and press **Select**.
- 4 Press  to call.

Add an Outgoing Call to Phone Book

If you have made a call and the number is not in phone book, it is possible to add it to phone book from the outgoing call list.

- 1 Press **Menu** to enter main menu.
- 2 Scroll to **Call register** and press **Select**.
- 3 Scroll to **Outgoing calls** and press **Select**.
- 4 Scroll to the desired call and press **Details**.
- 5 Press **Options**.
- 6 Scroll to **Add to phone book** and press **Select**.
- 7 Write the name of the contact using the digits 0-9 and press **Save**.

Delete an Outgoing Call from List

- 1 Press **Menu** to enter main menu.
- 2 Scroll to **Call register** and press **Select**.
- 3 Scroll to **Outgoing calls** and press **Select**.
- 4 Scroll to the desired call and press **Details**.
- 5 Press **Options** and scroll to **Delete from list**.
- 6 Press **Select** to confirm.

Missed Calls

Missed calls is a list of all your missed calls sorted by date and time of the call, starting with the latest call.

If the name and number of the missed call already exists in your phone book, the missed call is represented with the name of the contact. If the name and number do not exist in your phone book, the missed call is only represented by the number.

In both cases, missed call register provides details about missed calls, such as time, date and length of conversation.

It is possible to add name and number of a missed call to your phone book or to delete a missed call from the list.

View List of Missed Calls

- 1 Press **Menu** to enter main menu.
- 2 Scroll to **Call register** and press **Select**.
- 3 Scroll to **Missed calls** and press **Select**.
- 4 Press  to call.

Add a Missed Call to Phone Book

If you have a missed call and the number is not in phone book, it is possible to add it to phone book from the missed call list.

- 1 Press **Menu** to enter main menu.
- 2 Scroll to **Call register** and press **Select**.
- 3 Scroll to **Missed calls** and press **Select**.
- 4 Scroll to the desired missed call and press **Details**.
- 5 Press **Options**.
- 6 Scroll to **Add to phone book** and press **Select**.
- 7 Write the name of the contact using the digits 0-9 and press **Save**.

Delete a Missed Call from List

- 1 Press **Menu** to enter main menu.
- 2 Scroll to **Call register** and press **Select**.
- 3 Scroll to **Missed calls** and press **Select**.
- 4 Scroll to the desired missed call and press **Details**.
- 5 Press **Options** and scroll to **Delete from list**.
- 6 Press **Select** to confirm.

Delete Call Lists

The call register menu can store a total of 40 incoming, outgoing and missed calls. If the memory of call register is full, the handset automatically erases the oldest call when a new call needs to be stored in the call register.

Use the following delete functions to empty lists in the call register manually.

Delete all entries in a Call List

- 1 Press **Menu** to enter main menu.
- 2 Scroll to **Call Register** and press **Select**.
- 3 Scroll to **Delete** and press **Select**.
- 4 Scroll to the **incoming, outgoing or missed call** list, and then press **Select**.
- 5 Press **Yes** to empty list.

Delete All Calls from All Lists

- 1 Press **Menu** to enter main menu.
- 2 Scroll to **Call register** and press **Select**.
- 3 Scroll to **Delete** and press **Select**.
- 4 Scroll to **All calls** and press **Select**.
- 5 Press **Yes** to empty all folders.

Chapter 11: Messages

If supported by the subscribed system, you can write, send and receive messages from the messages menu. You write messages using the alphanumeric keyboard.

All messages are automatically stored in inbox or outbox.

The inbox is a list of all received messages, while the outbox is a list of all sent messages. Both lists are sorted by time and date, starting with the most recent.

If the name and number of a message already exist as a contact in your phone book, the message in the inbox or outbox will display the name of the sender or recipient. If the name and number do not exist in your phone book, the message will display the number of the sender or recipient.

Messages that have not yet been sent, will display an excerpt of the text.

Inbox and outbox can store up to 8 messages in total. A maximum of 72 letters, including spaces, is allowed for each message.

If the memory of inbox and outbox is full, the handset will automatically erase the oldest message when a new message needs to be stored.

Messaging is a system dependant feature.

Writing, Sending and Saving Messages

Write and Send a New Message

- 1 Press **Menu** to enter main menu.
- 2 Scroll to **Messages** and press **Select**.
- 3 Scroll to **New message** and press **Select**.
- 4 Write a message.
- 5 Optionally, you can use a template: Press **Options**, scroll to **Use template**, press **Select**, scroll to desired template, press **Options**, scroll to **Select** and press **Select**.
- 6 Press **Options** and scroll to **Send**, and then press **Select**.
- 7 Enter the recipients number or press **Search** to find the recipient.
- 8 To find a name you can:
 - Scroll until you reach the desired name. To scroll through the names quickly press the navigation key continuously.
 - Use quick search by pressing the first letter(s) (max. 5 letters) of the desired name.
- 9 Press **Select**.
- 10 If more than one number: scroll to desired number.
- 11 Press **Select** and then press **Send**.

12 When the message has been sent, the envelope icon  appears. Press **Ok** to accept.

Clear Text Field

Use the clear text function, when you are writing a new message and want to start all over.

- 1 Press **Options**.
- 2 Scroll to **Clear text** and press **Select**.

Save a New Message in Outbox

You can write a message and then save it in outbox for later handling.

- 1 Press **Menu** to enter main menu.
- 2 Scroll to **Messages** and press **Select**.
- 3 Scroll to **New message** and press **Select**.
- 4 Write a message and press **Options**.
- 5 Scroll to **Save message** and press **Select**.
- 6 Scroll to **Outbox** and press **Select**.

Edit a Message that Has not Been Sent

- 1 Press **Menu** to enter main menu.
- 2 Scroll to **Messages** and press **Select**.
- 3 Scroll to **Outbox** and press **Select**.
- 4 Scroll to the message you want to edit, and press **Select**.
- 5 Press **Options** and press **Select**.
- 6 Scroll to **Resend** and press **Select**.
- 7 Edit text.
- 8 Press **Options** and press **Send**.

Using Templates

You can create up to 8 templates.

When using a template in a message you have two options:

- Use a template from the very beginning of the process (see below).
- Insert a template in a message when you are in the process of writing a message.

Use a Template when You Begin a Message:

- 1 Press **Menu** to enter main menu.
- 2 Scroll to **Messages** and press **Select**.
- 3 Scroll to **Templates** and press **Select**.
- 4 Scroll to the desired template and press **Option**.
- 5 Scroll to **Select** and press **Select**.
- 6 If relevant, write additional text.
- 7 Press **Options**.
- 8 Scroll to **Send** and press **Select**.
- 9 Enter the recipients number or press **Search** to find the recipient.
- 10 To find a name you can:
 - Scroll until you reach the desired name. To scroll through the names quickly press the navigation key continuously.
 - Use quick search by pressing the first letter(s) (max. 5 letters) of the desired name.
- 11 Press **Select**.
- 12 If more than one number: scroll to desired number.
- 13 Press **Select** and then press **Send**.

Insert a Template in a Message

- 1 While in a message, press **Options**.
- 2 Scroll to Use template press **Select**.
- 3 Scroll to desired template, press **Options**.
- 4 Scroll to Select and press **Select**.

Save a New Message as a Template

After writing a message you can save it as a template for later use.

- 1 Press **Menu** to enter main menu.
- 2 Scroll to **Messages** and press **Select**.
- 3 Scroll to **New message** and press **Select**.
- 4 Write a message and press **Options**.
- 5 Scroll to **Save message** and press **Select**.
- 6 Scroll to **Templates** and press **Select**.
- 7 If memory is full: press **Ok**.
- 8 Scroll to the desired position and press **Select**.

Save a Received Message as a Template

You can save a message from inbox as a template for later use.

- 1 Press **Menu** to enter main menu.
- 2 Scroll to **Messages** and press **Select**.
- 3 Scroll to **Inbox** and press **Select**.
- 4 Scroll to desired message and press **Select**.
- 5 Press **Options**.
- 6 Scroll to **Forward** and press **Select**.
- 7 Press **Options**.
- 8 Scroll to **Save message** and press **Select**.
- 9 Scroll to **Templates** and press **Select**.
- 10 If memory is full, press **OK** to replace an old template.
- 11 Scroll to the template you want to replace and then press **Select**.

Delete a Single Template

Use this function to delete a template, or replace the template with a new template when the memory is full.

- 1 Press **Menu** to enter main menu.
- 2 Scroll to **Messages** and press **Select**.
- 3 Scroll to **Templates** and press **Select**.
- 4 Scroll to the desired template and press **Options**.
- 5 Scroll to **Erase** and press **Select**.
- 6 Press **Yes** to “**Erase message?**”

Reading Messages

In the following, you will find a description of how to read the messages.

The envelope icon , the text message and the contact information (if available) will appear in the display when you receive a message. Scroll up and down pressing top or bottom of the navigation key to read the entire message.

Remove the Message from the Display:

- Press **OK**.

The message is stored in inbox as read.

Replying to a Message

When you want to reply to a message from your inbox, you have four options:

- Write a new message in an empty screen
- Write in continuation of original text (received message)
- Insert a template
- Call back the handset that sent the message

Reply Using an Empty Screen

- 1** Press **Menu** to enter main menu.
- 2** Scroll to **Messages** and press **Select**.
- 3** Scroll to **Inbox** and press **Select**.
- 4** Scroll to the desired received message and press **Select**.
- 5** Press **Options**.
- 6** Scroll to **Reply** and press **Select**.
- 7** Scroll to **Empty screen** and press **Select**.
- 8** Write a message and press **Options**.
- 9** Scroll to **Send** and press **Select**.
- 10** Press **Send**.

Reply in Continuation of Original Text

Original text refers to the received text message.

- 1** Press **Menu** to enter main menu.
- 2** Scroll to **Messages** and press **Select**.
- 3** Scroll to **Inbox** and press **Select**.
- 4** Scroll to the desired received message and press **Select**.
- 5** Press **Options**.
- 6** Scroll to **Reply** and press **Select**.
- 7** Scroll to **Original text** and press **Select**.
- 8** Write a message in continuation of received message and press **Options**.
- 9** Scroll to **Send** and press **Select**.
- 10** Press **Send**.

Reply Using a Template

- 1** Press **Menu** to enter main menu.

- 2 Scroll to **Messages** and press **Select**.
- 3 Scroll to **Inbox** and press **Select**.
- 4 Scroll to the desired message and press **Select**.
- 5 Press **Options**.
- 6 Scroll to **Reply** and press **Select**.
- 7 Scroll to **Template** and press **Select**.
- 8 Scroll to the desired template and press **Options**.
- 9 Scroll to **Select** and press **Select**.
- 10 If relevant, write additional text.
- 11 Press **Options**.
- 12 Scroll to **Send** and press **Select**. Then press **Send**.

Call the Phone that Sent a Message:

You can call back the phone that sent a message, when a  is displayed in the status bar. You can do this when a message arrives, and when you are in the message inbox:

- 1 Press **Menu** to enter main menu.
- 2 Scroll to **Message**, and press **Select**.
- 3 Scroll to **Inbox** and press **Select**.
- 4 Scroll to the desired message and press **Select**.
- 5 Press 

Forward a Message

If you want to forward a message to a contact, do the following:

- 1 Press **Menu** to enter main menu.
- 2 Scroll to **Messages** and press **Select**.
- 3 Scroll to **Inbox** and press **Select**.
- 4 Scroll to the desired received message and press **Select**.
- 5 Press **Options**.
- 6 Scroll to **Forward** and press **Select**.
- 7 Press **Send**.
- 8 Press **Search** to find the receiver.
- 9 To find a name you can:
 - Scroll until you reach the desired name. To scroll through the names quickly press the navigation key continuously.
 - Use quick search by pressing the first letter(s) (max. 5 letters) of the desired name.

- 10 Press **Select**.
- 11 If more than one number: scroll to desired number.
- 12 Press **Select** and then press **Send**.

Resend a Message

If you want to resend a message to a contact, do the following:

- 1 Press **Menu** to enter main menu.
- 2 Scroll to **Messages** and press **Select**.
- 3 Scroll to **Outbox** and press **Select**.
- 4 Scroll to the desired message and press **Select**.
- 5 Press **Options**.
- 6 Scroll to **Resend** and press **Select**.
- 7 Press **Options**.
- 8 Scroll to **Send** and press **Select**.
- 9 Press **Send**.

Deleting Messages

Delete a Single Message

The handset will automatically erase the oldest message when the memory of inbox and outbox is full.

If you want to delete a message manually, do the following:

- 1 Press **Menu** to enter main menu.
- 2 Scroll to **Messages** and press **Select**.
- 3 Scroll to **Inbox** or **Outbox** and press **Select**.
- 4 Scroll to the desired message and press **Select**.
- 5 Press **Options**.
- 6 Scroll to **Erase** and press **Select**.
- 7 Press **Yes** to "Erase message?"

Delete All Read Messages from Inbox

Use this function to erase all read messages from inbox. This way you do not risk erasing messages that you have not had time to read yet.

- 1 Press **Menu** to enter main menu.

- 2 Scroll to **Messages** and press **Select**.
- 3 Scroll to **Erase messages** and press **Select**.
- 4 Scroll to **All read** and press **Select**.
- 5 Press **Yes** to “**Erase all read messages from Inbox?**”

Delete All Messages from Inbox or Outbox

Use this function to erase all messages from inbox.

- 1 Press **Menu** to enter main menu.
- 2 Scroll to **Messages** and press **Select**.
- 3 Scroll to **Erase messages** and press **Select**.
- 4 Scroll to **Inbox** and press **Select**.
- 5 Press **Yes** to delete all messages from Inbox or outbox.

Delete All Messages

Use this function to erase all messages from inbox and outbox.

- 1 Press **Menu** to enter main menu.
- 2 Scroll to **Messages** and press **Select**.
- 3 Scroll to **Erase messages** and press **Select**.
- 4 Scroll to **All** and press **Select**.
- 5 Press **Yes** to “**Erase all messages from all folders?**”

Chapter 12: Status

The status menu provides an overview of some of the handset settings and works as a shortcut to these. This makes it easy for you to change the settings according to your needs. The status menu also provides information about battery capacity.

Handset Options Status

You use the same navigation to view the status of the different handset options such as battery, ringer volume, firmware and so on.

To View Handset Options Status

- 1 Press **Menu** to enter main menu.
- 2 Scroll to **Status** and press **Select**.
- 3 Press the top or bottom of the navigation key to highlight the relevant menu item, and then press **Select** to enter the menu of the selected item.
- 4 Press **Back**.

Silent

When silent mode is turned on, the handset will not ring when a call arrives. However, you will still be able to see the arriving call in the display.

Auto Answer

When auto answer is turned on, the handset automatically goes off hook when ringing.

If subscribed to a wireless solution, the handset automatically goes on hook when calls are ended.

Battery

The battery function shows remaining battery capacity.

The indication on the display is not necessarily an exact reflection of the remaining speech time, but only an indication of the voltage on the battery.

Check Remaining Battery Capacity:

- 1 Press **Menu** to enter main menu.
- 2 Scroll to **Status** and press **Select**.

Ringer Tone

You can distinguish between an internal and external call by the ring tone. The ring tone of an internal call is followed by three short beeps (system dependent feature).

Volume

Adjusts ringing volume according to the noise level of the surrounding environment.

General Information

General handset information about:

- IPEI number of the handset
- Firmware version
- Hardware version
- Part number (item number)
- Product ID (P-ID)
- Regulatory model number (if available)

Chapter 13: Settings

The setting menu offers you the opportunity to customize the handset according to your needs. You can change the settings at any time.

In the following you find a description of how to customize the handset.

Ringling Volume

Adjust the Volume of the Ring Tone:

- 1 Press **Menu** to enter main menu.
- 2 Scroll to **Settings** and press **Select**.
- 3 Scroll to **Ringling volume** and press **Select**.
- 4 Press left (-) or right (+) side of navigation key to adjust the volume of the ring tone.
- 5 Press **Set**.

Ringling Tone

The ring tone is followed by a number indicating the chosen tone of the ringer.

You can distinguish between an internal and external call by the ring tone. The ring tone of an internal call is followed by three short beeps (system dependent feature).

Change the Ring Tone:

- 1 Press **Menu** to enter main menu.
- 2 Scroll to **Settings** and press **Select**.
- 3 Scroll to **Ringling tone** and press **Select**.
- 4 Scroll to the desired ring tone and press the **right side of the navigation key (+)** to listen to the ring tone. Repeat the process if you want listen to other ring tones.
- 5 Press the **left side of the navigation key (-)** to listen to the internal calls ring tone (system dependant feature.)
- 6 Scroll to the desired ring tone and press **Change** to select the new ring tone.

Alerting Volume

Alerts are short beeps that appear when:

- You receive a new message.
- You send a message.
- The handset is moving out of range.
- The handset is out of range.
- The battery capacity is low.
- You create a login.

Adjust Alerting Volume:

- 1 Press **Menu** to enter main menu.
- 2 Scroll to **Settings** and press **Select**.
- 3 Scroll to **Alerting volume** and press **Select**.
- 4 Press the left (-) or right (+) side of the navigation key to adjust the volume of the ringer.
- 5 Press **Set**.

Vibrator

When vibrator is turned on, the handset vibrates when an incoming call arrives. The handset does not vibrate when you receive a message or when the handset is charging.

Turn Vibrator On or Off:

- 1 Press **Menu** to enter main menu.
- 2 Scroll to **Settings** and press **Select**.
- 3 Scroll to **Vibrator** and press **Select**.
- 4 Scroll to **On** or **Off** and press **Change**.

Silent Mode

When silent mode is turned on, the handset does not ring when a call arrives, but the display shows the arriving call.

Turn Silent Mode On or Off:

- 1 Press **Menu** to enter main menu.
- 2 Scroll to **Settings** and press **Select**.
- 3 Scroll to **Silent mode** and press **Select**.
- 4 Scroll to **On** or **Off** and press **Change**.

-OR-

While on hook, press **Menu** followed by **#**.

In silent mode the ringer is muted and the vibrator activated.

When you activate silent mode, the vibrator spins shortly.

Changing Silent Mode Settings

When silent mode is turned on, you can select other ways of indicating incoming calls or messages:

- Display flashing
 - When turned on, the display flashes when an incoming call arrives.
- Vibrator
 - When turned on, the handset vibrates when an incoming call arrives.
- Short ring
 - When turned on, a short ring sounds when an incoming call arrives.

Change Silent Mode Settings

- 1 Press **Menu** to enter main menu.
- 2 Scroll to **Settings** and press **Select**.
- 3 Scroll to **Silent Mode** and press **Select**.
- 4 Scroll to **Settings** and press **Change**.
- 5 Scroll to the desired setting and press **Select**.

Auto Key Lock

Use auto key lock to prevent keys from being accidentally pressed.

With auto keylock turned on the handset will automatically lock keypad after 30 seconds.

Turn Auto Key Lock On or Off:

- 1 Press **Menu** to enter main menu.
- 2 Scroll to **Settings** and press **Select**.
- 3 Scroll to **Auto key lock** and press **Select**.
- 4 Scroll to **On** or **Off** and press **Change**.

-OR-

- 5 While on hook, press **Menu** followed by *****.

To answer a call when auto key lock is on, press . When you end the call, keypad automatically locks.

Backlight

The display backlight automatically turns on when an incoming call or message arrives, or a key is pressed.

The backlight turns off when handset is in standby mode after a preset period of time delay.

Set Backlight at Dimmed or Off

When setting display backlight at dimmed, display information can still be seen vaguely when handset is in standby mode. Turning display backlight off when handset is in standby mode will save battery power.

- 1 Press **Menu** to enter main menu.
- 2 Scroll to **Settings** and press **Select**.
- 3 Scroll to **Backlight** and press **Select**.
- 4 Press **Change** to set backlight **Dimmed** or **Off**.

Turn Backlight On

- 1 Press **Menu** to enter main menu.
- 2 Scroll to **Settings** and press **Select**.
- 3 Scroll to **Backlight** and press **Select**.
- 4 Press **Change** until **Dimmed** is selected.
- 5 Scroll to **delay** and press **Change**.
- 6 Press right (+) side of navigation key to set backlight delay to maximum.
- 7 Press **Set**.

Adjust Backlight Delay

You can adjust the period of time before backlight turns off or dimms when handset is in standby mode.

- 1 Press **Menu** to enter main menu.
- 2 Scroll to **Settings** and press **Select**.
- 3 Scroll to **Backlight** and press **Select**.
- 4 Scroll to **Delay** and press **Change**.
- 5 Press left (-) and right (+) side of navigation key to adjust backlight delay.
- 6 Press **Set**.

Auto Answer

When auto answer is turned on , the handset automatically goes off hook when an incoming call arrives.

If subscribed to a wireless solution, the handset automatically goes on hook when a call ends

Turn Auto Answer On or Off:

- 1 Press **Menu** to enter main menu.
- 2 Scroll to **Settings** and press **Select**.
- 3 Scroll to **Auto answer** and press **Select**.
- 4 Scroll to **On** or **Off** and press **Change**.

When charging, auto answer is inactive.

Change Auto Answer Settings

When auto answer is turned on, you can select if the handset should automatically go off hook and turn on the loudspeaker.

- 1 Press **Menu** to enter main menu.
- 2 Scroll to **Settings** and press **Select**.
- 3 Scroll to **Auto answer** and press **Select**.
- 4 Scroll to **Settings** and press **Change**.
- 5 Press **Select**.

Out of Range

The out of range indicator appears when handset is moving out of or already is out of range of base station.



Note

When the handset has been outside the range area, it can take up to 30 seconds before the handset is back on the system after re-entering range area.

Turn Out of Range On or Off:

- 1 Press **Menu** to enter main menu.
- 2 Scroll to **Settings** and press **Select**.
- 3 Scroll to **Out of range** and press **Select**.

- 4 Scroll to **On** or **Off** and press **Change**.

Changing Out of Range Settings

The handset offers two types of out of range alerts:

- Icon only
- Tone (beep) + icon

With the out of range indicator turned on:

- If the handset gets out of range, the no signal icon  appears in display. If tone + icon is selected, beeps sound with short intervals as long as the handset is out of range.

Change Out of Range Settings:

- 1 Press **Menu** to enter main menu.
- 2 Scroll to **Settings** and press **Select**.
- 3 Scroll to **Out of range** and press **Select**.
- 4 Scroll to **Settings** and press **Change**.
- 5 Scroll to the desired alert and press **Select**.

Advanced...

In the setting menu it is also possible to define the following advanced settings: Language, Long Key, Login and Time& Date.

Language

There are 14 predefined languages in the handset: Czech, Danish, German, English, Spanish, French, Italian, Dutch, Norwegian, Polish, Portuguese, Russian, Finnish and Swedish.

- 1 Press **Menu** to enter main menu.
- 2 Scroll to **Settings** and press **Select**.
- 3 Scroll to **Advanced** and press **Select**.
- 4 Scroll to **Language** and press **Select**.
- 5 Scroll to the desired language and press **Select**.

Long Key

The long key function supports system features and defines a long key press to digits between 0-9. The long key press can be defined as speed dials or as MSF messages. MSF messages are system dependent. If supported by the subscribed system, a MSF message sent to the system could for example return system features to the handset.

Change Long Key Definition

- 1 Press **Menu** to enter main menu.
- 2 Scroll to **Settings** and press **Select**.
- 3 Scroll to **Advanced** and press **Select**.
- 4 Scroll to **Long key** and press **Select**.
- 5 Scroll to desired definition and press **Change**.

Economy Mode

- 1 Press **Menu** to enter main menu.
- 2 Scroll to **Settings** and press **Select**.
- 3 Scroll to **Advanced** and press **Select**.
- 4 Scroll to **Economy Mode** and press **Select**.
- 5 Scroll to **On** or **Off** and press **Change**.

Login

Before you can use the registered handset it is necessary to subscribe the handset to a system (login). The handset can be subscribed to up to 2 different systems.

Select a Login

If you want to change to another system manually, do the following:

- 1 Press **Menu** to enter main menu.
- 2 Scroll to **Settings** and press **Select**.
- 3 Scroll to **Advanced** and press **Select**.
- 4 Scroll to **Login** and press **Select**.
- 5 Scroll to **Select Login** and press **Select**.
- 6 Scroll to the desired login and press **Select**.

Remove a Login

Logins can be removed from the system in use and from the other system (if connected).

Removing a login requires a password. Password is factory set at 0000.

- 1 Press **Menu** to enter main menu.
- 2 Scroll to **Settings** and press **Select**.
- 3 Scroll to **Advanced** and press **Select**.
- 4 Scroll to **Login** and press **Select**.
- 5 Scroll to **Remove login** and press **Select**.

- 6 Scroll to the desired login and press **Select**.
- 7 Enter your password and press **Ok**.
- 8 If the system in use is removed, it is necessary to select one of the remaining systems or to subscribe to a new one.

If one of the systems not chosen is removed, the handset remains connected to the system in use.

Create a Login

To create a login, the system must allow subscriptions to be made. Some systems also require an Authentication Code (AC). If more than one system currently permits subscription, you will need to know the ID of the system to which you want to subscribe. Authentication Codes and system ID's will be provided by the system administrator.

You can subscribe up to 2 systems, that is create 2 logins.

- 1 Press **Menu** to enter main menu.
- 2 Scroll to **Settings** and press **Select**.
- 3 Scroll to **Advanced** and press **Select**.
- 4 Scroll to **Login** and press **Select**.
- 5 Scroll to **Create login** and press **Select**. The handset will start searching for a system.
- 6 Scroll to the found system and press **Select**.
- 7 If required, enter an AC Code and press **Ok** to connect to the system.
- 8 Press **Ok**.

If the handset is already subscribed to 2 systems, you will have to remove a subscription before creating a new subscription.

Select a Login Automatically

When auto login is turned on, the handset automatically changes to another system when necessary. Auto login should only be used when systems are separate, with no overlaps.

To activate auto login your handset must be subscribed to two systems.

- 1 Press **Menu** to enter main menu.
- 2 Scroll to **Settings** and press **Select**.
- 3 Scroll to **Advanced** and press **Select**.
- 4 Scroll to **Login** and press **Select**.
- 5 Scroll to **Auto login** and press **Select**.
- 6 If **Off** is selected, press **Change** to select **On**.

The handset automatically selects a system. The selected system is marked with an A.

Time & Date

When you turn off the handset, the settings of time are deleted if the subscribed system does not resend the information to the handset.

Choose Time Format

- 1 Press **Menu** to enter main menu.
- 2 Scroll to **Settings** and press **Select**.
- 3 Scroll to **Advanced** and press **Select**.
- 4 Scroll to **Time & date** and press **Select**.
- 5 Scroll to **Time format** and press **Select**.
- 6 Scroll to desired time format and press **Change**.

Choose Date Format

- 7 Press **Menu** to enter main menu.
- 8 Scroll to **Settings** and press **Select**.
- 9 Scroll to **Advanced** and press **Select**.
- 10 Scroll to **Time & date** and press **Select**.
- 11 Scroll to **Date format** and press **Select**.
- 12 Scroll to desired date format and press **Change**.

Change Time

- 13 Press **Menu** to enter main menu.
- 14 Scroll to **Settings** and press **Select**.
- 15 Scroll to **Advanced** and press **Select**.
- 16 Scroll to **Time & date** and press **Select**.
- 17 Scroll to **Change time** and press **Select**.
- 18 Place cursor on the digit, you want to change.
- 19 Press a digit. The cursor will then automatically jump to the next digit.
- 20 Press **Change**.

Change Date

- 21 Press **Menu** to enter main menu.
- 22 Scroll to **Settings** and press **Select**.
- 23 Scroll to **Advanced** and press **Select**.
- 24 Scroll to **Time & date** and press **Select**.

- 25** Scroll to **Change date** and press **Select**.
- 26** Scroll to desired date format and press **Change**.
- 27** Place cursor on the digit, you want to change.
- 28** Press a digit. The cursor will then automatically jump to the next digit.
- 29** Press **Change**.

Chapter 14: General Information

Troubleshooting

The handset freezes.

- Remove and replace batteries. Press  to turn on the handset.

The handset does not ring.

- Check whether **Silent mode** is turned **On**.

The handset cannot find a system ID at Create Login.

- Check whether the system is set to allow subscriptions.

The handset cannot subscribe even if system ID has been found.

- Check if Authentication Code is necessary.

Not possible to turn on the handset.

- Check if batteries are connected. If yes, charge the batteries.

The handset turns off when receiving a call and going off-hook.

- Charge the batteries. If still a problem change the batteries as they might be defective.

Information

Error information

Improper function of the handset might be related to the infrastructure to which the handset is connected to.

Before declaring a handset for repair be sure that the main system is operating properly.

Technical Specification

Approvals

Access profile: EN 300 444 V1.4.1:2002

EMC: EN 301 489 - 1: Version 1.6.1

EN 301 489 - 6: Version 1.2.1

Radio: EN 301 406 V1.5.1

Safety: EN 60950 - 1:2006

Size and weight

Size: 150 x 50 x 20 mm/5.9 x 1.96 x 0.78 in

Weight: 105 gr/3.55 oz incl. batteries

Capacity

Active talking time up to 15 hours

Active talking time in economy mode up to 20 hours

Stand-by time up to 150 hours

Temperature and air pressure

Operating temperature incl. charging: 0-40°C/32-104°F

International Regulatory and Product Information

Table 1 CE

	<p>This Spectralink Butterfly has been marked with the CE mark. This mark indicates compliance with EEC Directive 1999/5/EC. A full copy of the Declaration of conformity can be obtained from Spectralink Europe ApS, Langmarksvej 34, 8700 Horsens</p>
---	--

Table 2 1999/5/EF

<p>Cesky [Czech]:</p>	<p>Spectralink tímto prohlašuje, že tento Spectralink Butterfly je ve shode se základními požadavky a dalšími příslušnými ustanoveními směrnice 1999/5/ES.</p>
<p>Dansk [Danish]:</p>	<p>Undertegnede Spectralink erklærer herved, at følgende udstyr Spectralink Butterfly overholder de væsentlige krav og øvrige relevante krav i direktiv 1999/5/EF.</p>
<p>Deutsch [German]:</p>	<p>Hiermit erkläre Spectralink, dass sich das Gerät Spectralink Butterfly in Übereinstimmung mit den grundlegenden Anforderungen und den übrigen einschlägigen Bestimmungen der Richtlinie 1999/5/EG befindet.</p>

Table 2 1999/5/EF

Eesti [Estonian]:	Käesolevaga kinnitab Spectralink seadme Spectralink Butterfly vastavust direktiivi 1999/5/EÜ põhinõuetele ja nimetatud direktiivist tulenevatele teistele asjakohastele sätetele.
English:	Hereby, Spectralink. declares that this Spectralink Butterfly is in compliance with the essential requirements and other relevant provisions of Directive 1999/5/EC.
Español [Spanish]:	Por medio de la presente Spectralink declara que el Spectralink Butterfly cumple con los requisitos esenciales y cualesquiera otras disposiciones aplicables o exigibles de la Directiva 1999/5/CE.
Ελληνική [Greek]:	ΜΕ ΤΗΝ ΠΑΡΟΥΣΑ Spectralink ΔΗΛΩΝΕΙ ΟΤΙ Spectralink Butterfly ΣΥΜΜΟΡΦΩΝΕΤΑΙ ΠΡΟΣ ΤΙΣ ΟΥΣΙΩΔΕΙΣ ΑΠΑΙΤΗΣΕΙΣ ΚΑΙ ΤΙΣ ΛΟΙΠΕΣ ΣΧΕΤΙΚΕΣ ΔΙΑΤΑΞΕΙΣ ΤΗΣ ΟΔΗΓΙΑΣ 1999/5/ΕΚ.
Français [French]:	Par la présente Spectralink déclare que l'appareil 7710/7720/7740 Handset est conforme aux exigences essentielles et aux autres dispositions pertinentes de la directive 1999/5/CE.
Italiano [Italian]:	Con la presente Spectralink dichiara che questo Spectralink Butterfly è conforme ai requisiti essenziali ed alle altre disposizioni pertinenti stabilite dalla direttiva 1999/5/CE.
Íslenska (Icelandic):	Hér með lýsir Spectralink yfir því að Spectralink Butterfly er í samræmi við grunnkröfur og aðrar kröfur, sem gerðar eru í tilskipun 1999/5/EC
Latviski [Latvian]:	Ar šo Spectralink deklare, ka Spectralink Butterfly atbilst Direktivas 1999/5/EK būtiskajam prasibam un citiem ar to saistītajiem noteikumiem.
Lietuviu [Lithuanian]:	Šiuo Spectralink deklaruoja, kad šis Spectralink Butterfly atitinka esminius reikalavimus ir kitas 1999/5/EB Direktyvos nuostatas.
Nederlands [Dutch]:	Hierbij verklaart Spectralink dat het toestel Spectralink Butterfly in overeenstemming is met de essentiële eisen en de andere relevante bepalingen van richtlijn 1999/5/EG.
Malti [Maltese]:	Hawnhekk, Spectralink, jiddikjara li dan [il-mudel tal-prodott] jikkonforma mal-htigijiet essenzjali u ma provvedimenti oħrajn rilevanti li hemm fid-Dirrettiva 1999/5/EC.
Magyar [Hungarian]:	Alulírott, Spectralink nyilatkozom, hogy a Spectralink Butterfly megfelel a vonatkozó alapvető követelményeknek és az 1999/5/EC irányelv egyéb előírásainak.
Norsk [Norwegian]:	Spectralink erklærer herved at utstyret Spectralink Butterfly er i samsvar med de grunnleggende krav og øvrige relevante krav i direktiv 1999/5/EF.
Polski [Polish]:	Niniejszym Spectralink oświadcza, że Spectralink Butterfly jest zgodne z zasadniczymi wymaganiami oraz innymi stosownymi postanowieniami Dyrektywy 1999/5/WE

Table 2 1999/5/EF

Português [Portuguese]:	Spectralink declara que este Spectralink Butterfly está conforme com os requisitos essenciais e outras disposições da Directiva 1999/5/CE.
Slovensko [Slovenian]:	Spectralink izjavlja, da je ta Spectralink Butterfly v skladu z bistvenimi zahtevami in ostalimi relevantnimi določili direktive 1999/5/ES.
Slovensky [Slovak]:	Spectralink týmto vyhlasuje, že Spectralink Butterfly spĺna základné požiadavky a všetky príslušné ustanovenia Smernice 1999/5/ES.
Suomi [Finnish]:	Spectralink vakuuttaa täten että Spectralink Butterfly tyyppinen laite on direktiivin 1999/5/EY oleellisten vaatimusten ja sitä koskevien direktiivin muiden ehtojen mukainen.
Svenska [Swedish]:	Härmed intygar Spectralink att denna Spectralink Butterfly står i överensstämmelse med de väsentliga egenskapskrav och övriga relevanta bestämmelser som framgår av direktiv 1999/5/EG.

Table 3 Explosive Device Proximity Warning

	Warning Do not operate your wireless network device near unshielded blasting caps or in an explosive environment unless the device has been modified to be especially qualified for such use.
---	--

Table 4 Explosive Device Proximity Warning

Waarschuwing	Gebruik dit draadloos netwerkapparaat alleen in de buurt van onbeschermd ontstekers of in een omgeving met explosieven indien het apparaat speciaal is aangepast om aan de eisen voor een dergelijk gebruik te voldoen.
Varoitus	Älä käytä johdotonta verkkolaitetta suojaamattomien räjäytysnallien läheisyydessä tai räjäytysalueella, jos laitetta ei ole erityisesti muunnettu sopivaksi sellaiseen käyttöön.
Attention	Ne jamais utiliser un équipement de réseau sans fil à proximité d'un détonateur non blindé ou dans un lieu présentant des risques d'explosion, sauf si l'équipement a été modifié à cet effet.
Warnung	Benutzen Sie Ihr drahtloses Netzwerkgerät nicht in der Nähe ungeschützter Sprengkapseln oder anderer explosiver Stoffe, es sei denn, Ihr Gerät wurde eigens für diesen Gebrauch modifiziert und bestimmt.
Avvertenza	Non utilizzare la periferica di rete senza fili in prossimità di un detonatore non protetto o di esplosivi a meno che la periferica non sia stata modificata a tale proposito.

Table 4 Explosive Device Proximity Warning

Advarsel	Ikke bruk den trådløse nettverksenheten nært inntil uisolerte fenghetter eller i et eksplosivt miljø med mindre enheten er modifisert slik at den tåler slik bruk.
Aviso	Não opere o dispositivo de rede sem fios perto de cápsulas explosivas não protegidas ou num ambiente explosivo, a não ser que o dispositivo tenha sido modificado para se qualificar especialmente para essa utilização.
¡Advertencia!	No utilizar un aparato de la red sin cable cerca de un detonador que no esté protegido ni tampoco en un entorno explosivo a menos que el aparato haya sido modificado con ese fin.
Varning!	Använd inte den trådlösa nätverksenheten i närheten av oskyddade tändhattar eller i en explosiv miljö om inte enheten modifierats för att kunna användas i sådana sammanhang.

Table 5 WEEE Marking

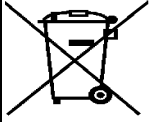
	<p>The WEEE Marking on this equipment indicates that the product must not be disposed of with unsorted waste, but must be collected separately.</p> <p>Visit www.Spectralink.com/battery-recycling for further guidance on battery recycling.</p>
--	--

Important Safety Instructions

Before using your telephone equipment, you should always follow basic safety instruction to reduce the risk of fire, electrical shock and injury to persons, and damage to property.

- 1 Read and understand all instructions
- 2 Follow all warnings and instructions including those marked on the product
- 3 Unplug this product before cleaning. Do not use liquid cleaners or aerosol cleaners. Use damp cloth for cleaning.
- 4 Do not install the telephone equipment in the bathroom or near a wash bowl, kitchen sink, or laundry tub, in a wet basement, or near a swimming pool
- 5 Slots or openings in the equipment are provided for ventilation to protect it from over-heating. These openings must not be blocked or covered.
- 6 The product should be operated only from the type of power source indicated on the instructions. If you are not sure of the type of power supply, consult your dealer or local power company.
- 7 Do not overload wall outlets and extension cords as this can result in fire or electrical shock.

- 8** Never push objects of any kind into this product through cabinet slots as they may touch dangerous voltage points or short out parts that could result in fire, electrical shock, or injury. Never spill liquid of any kind into this product.
- 9** To reduce the risk of electrical shock or burns, do not disassemble this product. Opening or removing covers may expose you to dangerous voltages, dangerous electrical current, or other risks. Incorrect reassemble can cause electrical shock when the appliance is subsequently used. If the product need repair, consult your dealer.
- 10** Refer servicing to qualified service personnel.
- 11** Avoid using telephone during an electrical storm. There may be a risk of electrical shock from lightning.
- 12** Do not use the telephone to report a gas leak in the vicinity of the leak.
- 13** Do not place the base or charger near microwave ovens, radio equipment, or non-ground connected televisions. These appliances may cause electrical interference to the base or handset
- 14** This telephone will not operate in the event of a blackout. Please keep a backup phone for emergencies.
- 15** Installation must be performed in accordance with all relevant national wiring rules.
- 16** Plug acts as Disconnect Device - The socket outlet to which this apparatus is connected must be installed near the equipment and must always be readily accessible.
- 17** This device and its antenna must not be co-located or operating in conjunction with any other antenna or transmitter.
- 18** Warning: The earpiece/mouthpiece region on the handset can attract and retain small metallic objects.

Intrinsic safety

Do not use the handset in conditions where there is a danger of electrically ignited explosions.

Exposure to sunlight, heat and moisture

Do not expose the cordless phone to direct sunlight for long periods. Keep the cordless phone away from excessive heat and moisture.

Spare parts and accessories

Use only approved spare parts and accessories. The operation of non-approved parts cannot be guaranteed and may even cause damage.

Power failure

In the event of a power failure or flat battery, you cannot use the handset to make or receive calls.

Battery Precautions

- 1 Exercise care in handling batteries in order not to short the batteries with conducting materials such as rings, bracelets, and keys. The batteries or conducting material may overheat and cause burns or fire.
- 2 Do not open or mutilate the batteries, released electrolyte is corrosive and may cause damage to the eyes or skin. The electrolyte may be toxic if swallowed.
- 3 During charging batteries heat up. This is normal and not dangerous.
- 4 Battery installation Caution - Danger of Explosion if Battery is incorrectly replaced. Replace only with the same or equivalent type recommended by the manufacturer. Dispose of used batteries according to the manufacturer's instructions.

Notices

Before installing this equipment, users should ensure that it is permissible to be connected to the facilities of the local telecommunications company. The equipment must also be installed using an acceptable method of connection. The customer should be aware that compliance with the above conditions may not prevent degradation of service in some situations.

Repairs to certified equipment should be coordinated by a representative designated by the supplier. Any repairs or alterations made by the user to this equipment, or equipment malfunctions, may give the telecommunications company cause to request the user to disconnect the equipment.

Users should ensure for their own protection that the electrical ground connections of the power utility, telephone lines and internal metallic water pipe system, if present, are connected together. This precaution may be particularly important in rural areas.

EMC:CAUTIONS

Users should not attempt to make such connections themselves, but should contact the appropriate electric inspection authority, or electrician, as appropriate.

If your telephone equipment causes harm to the telephone network, the telephone company may ask you to disconnect the system from the line until the problem has been corrected or they may discontinue your service temporarily. If possible, they will notify you in advance. But if advance notice is not practical, you should be notified as soon as possible. You will be informed of your right to file a complaint with the FCC.

Your telephone company may make changes in its facilities, equipment, operations, or procedures that could affect the proper functioning of your telephone system. If they do and it is possible, you will be notified in advance to give you an opportunity to maintain uninterrupted telephone service. If you experience trouble with this telephone system, disconnect it from the network until the problem has been corrected or until you are sure that the equipment is not malfunctioning.

Note

This equipment has been tested and found to comply with the limits for a class B digital device, pursuant to local regulations. These limits are designed to provide reasonable protection against harmful interference in a residential installation. This equipment generates, uses and can radiate radio frequency energy and, if not installed and used in accordance with the instructions, may cause harmful interference to radio communications.

However, there is no guarantee that interference will not occur in a particular installation. If this equipment does cause harmful interference to radio or television reception, which can be determined by turning the equipment off and on, the user is encouraged to try to correct the interference by one or more of the following measures:

- Reorient or relocate the receiving antenna.
- Increase the separation between the equipment and receiver.
- Connect the equipment into an outlet on a circuit different from that to which the receiver is connected.
- Consult the dealer or an experienced radio/TV technician for help.

Hearing Aid Compatibility

This equipment is hearing-aid compatible, as defined in Section 68.316 of Part 68 FCC Rules.

FCC Note

This device complies with part 15 of the FCC rules. Operation is subject to the following two conditions: (1) This device may not cause harmful interference, and (2) this device must accept any interference received, including interference that may cause undesired operation.

SAR

Device has been tested for SAR compliance for head and body worn configurations. The highest reported SAR value is: head 0.00981 W/kg and body worn 0.020 W/kg.

IC Note: Operation is subject to the following two conditions: (1) This device may not cause interference, and (2) this device must accept any interference, including interference that may cause undesired operation of the device.

The Term "IC": before the certification/registration number only signifies that the Industry Canada technical specifications were met.

Privacy of communications may not be ensured when using this telephone.

Power Outage

In the event of a power outage, your cordless telephone will not operate. The cordless telephone requires electricity for operation. You should have a telephone which does not require electricity available for use during power outages.

Information to user

The users manual or instruction manual for an intentional or unintentional radiator shall caution the user that changes or modifications not expressly approved by the party responsible for compliance could void the user's authority to operate the equipment.

NOTE EMC

Cet appareil a été soumis à un essai et jugé conforme aux normes régissant les limites établies pour un dispositif numérique de classe B, conformément aux règlements locaux. Ces limites visent à assurer une protection raisonnable contre des interférences pouvant nuire à l'appareil utilisé dans un secteur résidentiel. Cet équipement génère et utilise des radiofréquences, et peut en émettre. S'il n'est pas installé et utilisé selon les directives fournies, il risque de perturber les radiocommunications. L'exploitation de cet appareil dans un secteur particulier est toutefois susceptible de produire des interférences nuisibles. Si cet équipement provoque des interférences lors de la réception des radiofréquences ou des fréquences de télévision, ce qui peut être vérifié en mettant l'appareil hors tension, puis en le remettant sous tension, l'utilisateur doit prendre l'une des mesures suivantes pour corriger la situation:

- réorienter ou relocaliser l'antenne de réception;
- augmenter la distance entre l'appareil et l'antenne de réception;
- brancher l'appareil à une prise d'un circuit différent de celui auquel l'antenne est branchée;
- consulter le détaillant ou un technicien en radiotélévision d'expérience pour obtenir de l'aide.

PTC General Warning

The grant of a Telepermit for any item of terminal equipment indicates only that Telecom has accepted that the item complies with minimum conditions for connection to its network. It indicates no endorsement of the product by Telecom, nor does it provide any sort of warranty. Above all, it provides no assurance that any item will work correctly in all respects with another item of Telepermitted equipment of a different make or model, nor does it imply that any product is compatible with all of Telecom's network services.

Echo Cancellation

Echo cancellers are not normally required in the Telecom PSTN because geographic delays are acceptable where CPE return loss is maintained within Telepermit limits. However, those private networks making use of

over IP technology are required to provide echo cancellation for all voice calls. The combined effect of audio/VoIP conversion delay and IP routing delay can cause the echo cancellation time of 64 mS or more to be required.

Spectralink Product Warranty Statement

The software included in this Product (including, without limitation, firmware and all updated thereto, including any software that may be downloaded electronically via the internet or otherwise (the "Software") is licensed, not sold. Customer shall not reverse compile, disassemble or otherwise reverse engineer, embed within any other software product, or modify in any manner with respect thereto, the Software in whole or in part.

THE TERMS AND CONDITIONS APPLICABLE TO SPECTRALINK'S LIMITED WARRANTY ARE AS SET FORTH BELOW (AND ARE ALSO INCLUDED IN THE DOCUMENTATION PACKAGED WITH NEW SPECTRALINK PRODUCTS):

LIMITED WARRANTY. Spectralink warrants to the end user ("Customer") that the product will be free from defects in workmanship and materials, under normal use and service, for one year, or such longer period as Spectralink may announce publicly from time to time for particular products, from the date of purchase from Spectralink or its authorized reseller. Spectralink's sole obligation under this express warranty shall be, at Spectralink's option and expense, to repair the defective product or part, deliver to Customer an equivalent product or part to replace the defective item, or if neither of the two foregoing options is reasonably available, Spectralink may, in its sole discretion, refund to Customer the purchase price paid for the defective product. All products that are replaced will become the property of Spectralink. Replacement products or parts may be new or reconditioned. Spectralink warrants any replaced or repaired product or part for ninety (90) days from shipment, or the remainder of the initial warranty period, whichever is longer. Products returned to Spectralink must be sent prepaid and packaged appropriately for safe shipment, and it is recommended that they be insured or sent by a method that provides for tracking of the package. Responsibility for loss or damage does not transfer to Spectralink until the returned item is received by Spectralink. The repaired or replaced item will be shipped to Customer, at Spectralink's expense, not later than thirty (30) days after Spectralink receives the defective product, and Spectralink will retain risk of loss or damage until the item is delivered to Customer.

EXCLUSIONS

Spectralink will not be liable under this limited warranty if its testing and examination disclose that the alleged defect or malfunction in the product does not exist or results from:

- Failure to follow Spectralink's installation, operation, or maintenance instructions.
- Unauthorized product modification or alteration.
- Unauthorized use of common carrier communication services accessed through the product.
- Abuse, misuse, negligent acts or omissions of Customer and persons under Customer's control; or
- Acts of third parties, acts of God, accident, fire, lightning, power surges or outages, or other hazards.

WARRANTY EXCLUSIVE

IF A SPECTRALINK PRODUCT DOES NOT OPERATE AS WARRANTED ABOVE, CUSTOMER'S SOLE REMEDY FOR BREACH OF THAT WARRANTY SHALL BE REPAIR, REPLACEMENT, OR REFUND OF THE PURCHASE PRICE PAID, AT SPECTRALINK'S

OPTION. TO THE FULL EXTENT ALLOWED BY LAW, THE FOREGOING WARRANTIES AND REMEDIES ARE EXCLUSIVE AND ARE IN LIEU OF ALL OTHER WARRANTIES, TERMS, OR CONDITIONS,

EXPRESS OR IMPLIED, EITHER IN FACT OR BY OPERATION OF LAW, STATUTORY OR OTHERWISE, INCLUDING WARRANTIES, TERMS, OR CONDITIONS OF MERCHANTABILITY, FITNESS FOR A PARTICULAR PURPOSE, SATISFACTORY QUALITY, CORRESPONDENCE WITH DESCRIPTION, AND NON-INFRINGEMENT, ALL OF WHICH ARE EXPRESSLY DISCLAIMED. SPECTRALINK NEITHER ASSUMES NOR AUTHORIZES ANY OTHER PERSON TO ASSUME FOR IT ANY OTHER LIABILITY IN CONNECTION WITH THE SALE, INSTALLATION, MAINTENANCE OR USE OF ITS PRODUCTS.

SUPPORT & SERVICE AGREEMENTS

If you purchased your product from a Spectralink Authorized Reseller, contact the Authorized Reseller for information about support and service agreements applicable to your product. For information on Spectralink service, go to the Spectralink web site www.spectralink.com, products and services menu, or call 1-800-775-5330, or call your local Spectralink Office, as listed on the Spectralink Web site.

LIMITATION OF LIABILITY

TO THE FULL EXTENT ALLOWED BY LAW, SPECTRALINK EXCLUDES FOR ITSELF AND ITS SUPPLIERS ANY LIABILITY, WHETHER BASED IN CONTRACT OR TORT (INCLUDING NEGLIGENCE), FOR INCIDENTAL, CONSEQUENTIAL, INDIRECT, SPECIAL, OR PUNITIVE DAMAGES OF ANY KIND, OR FOR LOSS OF REVENUE OR PROFITS, LOSS OF BUSINESS, LOSS OF INFORMATION OR DATA, OR OTHER FINANCIAL LOSS ARISING

OUT OF OR IN CONNECTION WITH THE SALE, INSTALLATION, MAINTENANCE, USE, PERFORMANCE, FAILURE, OR INTERRUPTION OF ITS PRODUCTS, EVEN IF SPECTRALINK OR ITS AUTHORIZED RESELLER HAS BEEN ADVISED OF THE POSSIBILITY OF SUCH DAMAGES, AND LIMITS ITS LIABILITY TO REPAIR, REPLACEMENT, OR REFUND OF THE PURCHASE PRICE PAID, AT SPECTRALINK'S OPTION. THIS DISCLAIMER OF LIABILITY FOR DAMAGES WILL NOT BE AFFECTED IF ANY REMEDY PROVIDED HEREIN SHALL FAIL OF ITS ESSENTIAL PURPOSE.

DISCLAIMER. Some countries, states, or provinces do not allow the exclusion or limitation of implied warranties or the limitation of incidental or consequential damages for certain products supplied to consumers, or the limitation of liability for personal injury, so the above limitations and exclusions may be limited in their application to you. When the implied warranties are not allowed to be excluded in their entirety, they will be limited to the duration of the applicable written warranty. This warranty gives you specific legal rights which may vary depending on local law.

GOVERNING LAW. This Limited Warranty and Limitation of Liability shall be governed by the laws of the State of California, U.S.A., and by the laws of the United States, excluding their conflicts of laws principles. The United Nations Convention on Contracts for the International Sale of Goods is hereby excluded in its entirety from application to this Limited Warranty and Limitation of Liability.

END-USER LICENSE AGREEMENT FOR SPECTRALINK SOFTWARE

IMPORTANT - READ CAREFULLY BEFORE USING THE SOFTWARE PRODUCT:

This End-User License Agreement ("Agreement") is a legal agreement between you (either an individual or a single entity) and Spectralink for the SPECTRALINK® SOFTWARE PRODUCT licensed by Spectralink in Europe, the Middle East, Africa, and Asia Pacific, or the SPECTRALINK SOFTWARE PRODUCT licensed by Spectralink Spectralink in the rest of the world (collectively referred to herein as "SPECTRALINK"). The SOFTWARE PRODUCT includes computer software as attached hereto and may include associated media, printed materials, and "online" or electronic documentation ("SOFTWARE PRODUCT"). By clicking "I agree" or by installing, copying, or otherwise using the SOFTWARE PRODUCT, you agree to be bound by the terms of this Agreement. If you do not agree to the terms of this Agreement, do not install or use the SOFTWARE PRODUCT, and return it to your place of purchase for a full refund. The SOFTWARE PRODUCT is protected by copyright laws and international copyright treaties, as well as other intellectual property laws and treaties. The SOFTWARE PRODUCT is licensed (not sold) to you, and its use is subject to the terms of this Agreement.

1. GRANT OF LICENSE.

Subject to the terms of this Agreement, SPECTRALINK grants to you a non-exclusive license to install and use the SOFTWARE PRODUCT on the SPECTRALINK product with which this SOFTWARE PRODUCT is supplied (the "PRODUCT"). You may use the SOFTWARE PRODUCT only in connection with the use of the PRODUCT. You are not permitted to lease, rent, distribute or sublicense the SOFTWARE PRODUCT or to use the SOFTWARE PRODUCT in a time-sharing arrangement or in any other unauthorized manner. Further, no license is granted to you in the human readable code of the SOFTWARE PRODUCT (source code). Except as provided below, this License Agreement does not grant you any rights to patents, copyrights, trade secrets, trademarks, or any other rights in respect to the SOFTWARE PRODUCT.

2. DESCRIPTION OF OTHER RIGHTS AND LIMITATIONS.

2.1 Limitations on Reverse Engineering, Decompilation, and Disassembly.

You may not reverse engineer, decompile, or disassemble the SOFTWARE PRODUCT, except and only to the extent that such activity is expressly permitted by applicable law notwithstanding this limitation. The SOFTWARE PRODUCT is licensed as a single product. Its component parts may not be separated for use on more than one PRODUCT.

2.2 Back-up

Except as expressly provided for under this Agreement you may not copy the SOFTWARE PRODUCT; except, however, you may keep one copy of the SOFTWARE PRODUCT and, if applicable, one copy of any previous version, for back-up purposes, only to be used in the event of failure of the original. All copies of the SOFTWARE PRODUCT must be marked with the proprietary notices provided on the original SOFTWARE PRODUCT. You may not reproduce the supporting documentation accompanying the SOFTWARE PRODUCT.

2.3 Modifications

You may not modify, translate or create derivative works of the SOFTWARE PRODUCT.

2.4 Proprietary Notices

You may not remove or obscure any proprietary notices on or in the SOFTWARE PRODUCT or the supporting documentation.

2.5 Software Transfer

You may permanently transfer all of your rights under this Agreement, provided you retain no copies, you transfer all of the SOFTWARE PRODUCT (including all component parts, the media and printed materials, any upgrades, this Agreement, and, if applicable, the Certificate of Authenticity), and the recipient agrees to the terms of this Agreement. If the SOFTWARE PRODUCT is an upgrade, any transfer must include all prior versions of the SOFTWARE PRODUCT. However, if the SOFTWARE PRODUCT is marked "Not for Resale" or "NFR", you may not resell it or otherwise transfer it for value.

2.6 Copyright

All title and copyrights in and to the SOFTWARE PRODUCT (including but not limited to any images, photographs, animations, video, audio, music, text, and "applets" incorporated into the SOFTWARE PRODUCT), the accompanying printed materials, and any copies of the SOFTWARE PRODUCT are owned by SPECTRALINK or its suppliers. The SOFTWARE PRODUCT is protected by copyright laws and international treaty provisions. Title, ownership rights, and intellectual property rights in the SOFTWARE PRODUCT shall remain in SPECTRALINK or its suppliers. Title and related rights in the content accessed through the SOFTWARE PRODUCT is the property of such content owner and may be protected by applicable law. This Agreement gives you no rights in such content.

2.7 Confidentiality

The SOFTWARE PRODUCT contains valuable proprietary information and trade secrets of SPECTRALINK and its suppliers and you shall protect the confidentiality of, and avoid disclosure and unauthorized use of, the SOFTWARE PRODUCT.

2.8 Dual-Media Software

You may receive the SOFTWARE PRODUCT in more than one medium. Regardless of the type or size of medium you receive, you may use only one medium that is appropriate for your single PRODUCT. You may not use or install the other medium on another PRODUCT.

2.9 Reservation

SPECTRALINK reserves all rights in the SOFTWARE PRODUCT not expressly granted to you in this Agreement.

3. SUPPORT SERVICES

SPECTRALINK may provide you with support services related to the SOFTWARE PRODUCT ("SUPPORT SERVICES"). Use of SUPPORT SERVICES is governed by the SPECTRALINK policies and programs described in the SPECTRALINK - provided materials. Any supplemental software code provided to you as part of the SUPPORT SERVICES is considered

part of the SOFTWARE PRODUCT and is subject to the terms and conditions of this Agreement. With respect to technical information you provide to SPECTRALINK as part of the SUPPORT SERVICES, SPECTRALINK may use such information for its business purposes, including for product support and development. SPECTRALINK will not utilize such technical information in a form that personally identifies you.

4. TERMINATION

Without prejudice to any other rights, SPECTRALINK may terminate this Agreement if you fail to comply with any of the terms and conditions of this Agreement. In such event, you must destroy all copies of the SOFTWARE PRODUCT and all of its component parts. You may terminate this Agreement at any time by destroying the SOFTWARE PRODUCT and all of its component parts.

5. UPGRADES

If the SOFTWARE PRODUCT is labeled as an upgrade, you must be properly licensed to use the software identified by SPECTRALINK as being eligible for the upgrade in order to use the SOFTWARE PRODUCT. A SOFTWARE PRODUCT labeled as an upgrade replaces and/or supplements the software that formed the basis for your eligibility for the upgrade. You may use the resulting upgraded SOFTWARE PRODUCT only in accordance with the terms of this Agreement. If the SOFTWARE PRODUCT is an upgrade of a component of a package of software programs that you licensed as a single product, the SOFTWARE PRODUCT may be used and transferred only as part of that single SOFTWARE PRODUCT package and may not be separated for use on more than one PRODUCT.

6. WARRANTY AND WARRANTY EXCLUSIONS

6.1 Limited Warranty

SPECTRALINK warrants that (a) the SOFTWARE PRODUCT will perform substantially in accordance with the accompanying documentation for a period of ninety (90) days from the date of receipt by you, and (b) any SUPPORT SERVICES provided by SPECTRALINK shall be substantially as described in applicable written materials provided to you by SPECTRALINK, and SPECTRALINK support engineers will make commercially reasonable efforts to solve any problem issues. SPECTRALINK does not warrant that your use of the SOFTWARE PRODUCT will be uninterrupted or error free, or that all defects in the SOFTWARE PRODUCT will be corrected. SPECTRALINK's sole obligation under this express warranty shall be, at SPECTRALINK's option and expense, to refund the purchase price paid by you for any defective software product which is returned to SPECTRALINK with a copy of your receipt, or to replace any defective media with software which substantially conforms to applicable SPECTRALINK published specifications. Any replacement SOFTWARE PRODUCT will be warranted for the remainder of the original warranty period or thirty (30) days, whichever is longer.

6.2 Warranties Exclusive

IF THIS SOFTWARE PRODUCT DOES NOT OPERATE AS WARRANTED ABOVE, YOUR SOLE REMEDY FOR BREACH OF THAT WARRANTY SHALL BE REPAIR, REPLACEMENT, OR REFUND OF THE PURCHASE PRICE PAID, AT SPECTRALINK'S OPTION. TO THE FULL EXTENT ALLOWED BY LAW, THE FOREGOING WARRANTIES AND REMEDIES ARE EXCLUSIVE AND ARE IN LIEU OF ALL OTHER WARRANTIES, TERMS, OR CONDITIONS,

EXPRESS OR IMPLIED, EITHER IN FACT OR BY OPERATION OF LAW, STATUTORY OR OTHERWISE, INCLUDING WARRANTIES, TERMS, OR CONDITIONS OF MERCHANTABILITY, FITNESS FOR A PARTICULAR PURPOSE, SATISFACTORY QUALITY, CORRESPONDENCE WITH DESCRIPTION, AND NON-INFRINGEMENT, ALL OF WHICH ARE EXPRESSLY DISCLAIMED. SPECTRALINK NEITHER ASSUMES NOR AUTHORIZES ANY OTHER PERSON TO ASSUME FOR IT ANY OTHER LIABILITY IN CONNECTION WITH THE SALE, INSTALLATION, MAINTENANCE OR USE OF THIS SOFTWARE PRODUCT. SPECTRALINK SHALL NOT BE LIABLE UNDER THIS WARRANTY IF ITS TESTING AND EXAMINATION DISCLOSE THAT THE ALLEGED DEFECT OR MALFUNCTION IN THE SOFTWARE PRODUCT DOES NOT EXIST OR WAS CAUSED BY YOUR OR ANY THIRD PERSON'S MISUSE, NEGLIGENCE, IMPROPER INSTALLATION OR TESTING, UNAUTHORIZED ATTEMPTS TO MODIFY THE PRODUCT, OR ANY OTHER CAUSE BEYOND THE RANGE OF THE INTENDED USE, OR BY ACCIDENT, FIRE, LIGHTNING, POWER CUTS OR OUTAGES, OTHER HAZARDS, OR ACTS OF GOD.

7. LIMITATION OF LIABILITY

TO THE MAXIMUM EXTENT PERMITTED BY APPLICABLE LAW, IN NO EVENT SHALL SPECTRALINK OR ITS SUPPLIERS BE LIABLE FOR ANY SPECIAL, INCIDENTAL, INDIRECT, OR CONSEQUENTIAL DAMAGES WHATSOEVER (INCLUDING, WITHOUT LIMITATION, DAMAGES FOR LOSS OF BUSINESS PROFITS, BUSINESS INTERRUPTION, LOSS OF BUSINESS INFORMATION, OR ANY OTHER PECUNIARY LOSS) ARISING OUT OF THE USE OF OR INABILITY TO USE THE SOFTWARE PRODUCT OR THE PROVISION OF OR FAILURE TO PROVIDE SUPPORT SERVICES, EVEN IF SPECTRALINK HAS BEEN ADVISED OF THE POSSIBILITY OF SUCH DAMAGES. IN ANY CASE, SPECTRALINK'S ENTIRE LIABILITY SHALL BE LIMITED TO THE GREATER OF THE AMOUNT ACTUALLY PAID BY YOU FOR THE SOFTWARE PRODUCT OR U.S. \$5.00. PROVIDED, HOWEVER, IF YOU HAVE ENTERED INTO A SPECTRALINK SUPPORT SERVICES AGREEMENT, SPECTRALINK'S ENTIRE LIABILITY REGARDING SUPPORT SERVICES SHALL BE GOVERNED BY THE TERMS OF THAT AGREEMENT.

8. DISCLAIMER

Some countries, states, or provinces do not allow the exclusion or limitation of implied warranties or the limitation of incidental or consequential damages for certain products supplied to consumers, or the limitation of liability for personal injury, so the above limitations and exclusions may be limited in their application to you. When the implied warranties are not allowed to be excluded in their entirety, they will be limited to the duration of the applicable written warranty. This warranty gives you specific legal rights which may vary depending on local law.

9. EXPORT CONTROLS

The SOFTWARE PRODUCT may not be downloaded or otherwise exported or re-exported (i) into (or to a national or resident of) Cuba, Iraq, Libya, North Korea, Yugoslavia, Iran, Syria, Republic of Serbia, or any other country to which the U.S. has embargoed goods; or (ii) to anyone on the U.S. Treasury Department's list of Specially Designated Nationals or the U.S. Commerce Department's Table of Denial Orders. By downloading or using the SOFTWARE PRODUCT, you are agreeing to the foregoing and you are representing and warranting that you are not located in,

under the control of, or a national or resident of any such country or on any such list. If you obtained this SOFTWARE PRODUCT outside of the United States, you are also agreeing that you will not export or re-export it in violation of the laws of the country in which it was obtained.

10. MISCELLANEOUS

10.1 Governing Law

This Agreement shall be governed by the laws of the State of California as such laws are applied to agreements entered into and to be performed entirely within California between California residents, and by the laws of the United States. The United Nations Convention on Contracts for the International Sale of Goods (1980) is hereby excluded in its entirety from application to this Agreement.

10.2 General

This Agreement represents the complete agreement concerning this license and may amended only by a writing executed by both parties. If any provision of this Agreement is held to be unenforceable, such provision shall be reformed only to the extent necessary to make it enforceable.

10.3 Contact

If you have any questions concerning this Agreement, or if you desire to contact SPECTRALINK for any reason, please contact the SPECTRALINK office serving your country.

10.4 U.S. Government Restricted Rights

The SOFTWARE PRODUCT and documentation are provided with RESTRICTED RIGHTS. The SOFTWARE PRODUCT programs and documentation are deemed to be "commercial computer software" and "commercial computer software documentation", respectively, pursuant to DFAR Section 227.7202 and FAR 12.212(b), as applicable. Any use, modification, reproduction, release, performance, display or disclosure of the SOFTWARE PRODUCT programs and/or documentation by the U.S. Government or any of its agencies shall be governed solely by the terms of this Agreement and shall be prohibited except to the extent expressly permitted by the terms of this Agreement. Any technical data provided that is not covered by the above provisions is deemed to be "technical data-commercial items" pursuant to DFAR Section 227.7015(a). Any use, modification, reproduction, release, performance, display or disclosure of such technical data shall be governed by the terms of DFAR Section 227.7015(b).

©2014 Spectralink Corporation. All rights reserved.

Specifications subject to change without notice.

Spectralink Corporation
2560 55th Street
Boulder CO 80301, USA
Spectralink Europe ApS

Spectralink Europe ApS
Langmarksvej 34
DK-8700 Horsens
Tel. +45 7560 2850

infodk@spectralink.com
www.spectralink.com